

---

# Coolant Pump

Model : VKN-e/VKP-e

**⚠ WARNING**

Do not operate, service or inspect this pump until you have read and understood this manual.

Keep this manual in a safe place where it can be consulted at any time.

To : All mechanical Contractor

---

Make sure to supply copies of this manual to the customer's operator maintenance and inspection personnel.

## Limited warranties

1. In the event of a failure or breakage under proper use of the product during the warranty period, equipment supplied by Teral Inc. shall be repaired or replaced free of charge within the scope of the relevant part, provided that such failure or breakage is attributable to inadequacy of the design or workmanship of the equipment.  
The warranty period of this product shall be one year after the date of delivery.
2. The warranty mentioned in the above clause shall be only the mechanical warranty of the defective part, and shall not cover any expenses or other damage arising from the failure or breakage.
3. In the event of the following failures and breakage, the costs of the repairs shall be borne by the user.
  - (1) Failures and breakage attributable to equipment that was not delivered by Teral Inc.
  - (2) Failures and breakage after the expiration of the warranty period
  - (3) Failures and breakage caused by disasters or force majeure, such as fire, acts of God, or earthquakes
  - (4) Failures and breakage resulting from repairs or modifications made without the consent of Teral Inc.
  - (5) Failures and breakage when parts other than those designated by Teral Inc. are used
  - (6) Failures and breakage caused by use or storage outside the specification range
4. Teral Inc. shall not be liable for the damage caused by incorrect or reckless use of the pump. Cost and expenses incurred for sending engineer(s) in such a case shall be borne by the user.
5. If the cause of the failure is unclear, necessary actions shall be determined through mutual consultation.

### <Paid repairs>

After the expiration of the warranty period, the costs of investigation and repairs related to the product shall be borne by the user. For any failures that have occurred within the warranty period but that fall outside the above-mentioned warranty coverage, Teral Inc. shall carry out repairs and investigation for a fee. Please give us the instructions to do so in such a case.

## Purpose of this manual

The purpose of this manual is to provide the user with detailed information necessary to properly operate, maintain and inspect the pump. Incorrect operation of this product may lead to an unexpected accident.

Please use the product correctly according to this instruction manual.

This manual contains the following information and is intended for persons experienced in the operation of pumps, or for those who have been trained by such experienced operators. Only qualified personnel such as licensed electrical engineers are allowed to carry out the electrical wiring work.

## Contents

	(Page)
<b>Limited warranties</b> .....	I
<b>Purpose of this manual</b> .....	II
<b>Contents</b> .....	II
1. Safety precautions.....	1-1
1.1 Types and meanings of warning terms and graphic symbols .....	1-1
1.2 Safety precautions.....	1-1
1.3 Location of warning labels and caution labels.....	1-3
2. Configuration and overview of the pump.....	2-1
2.1 Part names and functions.....	2-1
2.2 Naming rule of the model codes.....	2-1
2.3 Standard specifications .....	2-2
2.4 Information indicated on the nameplate .....	2-3
2.5 Specification table.....	2-4
2.6 Dimensional outline drawing .....	2-5
2.7 Internal structure drawing.....	2-6
3. Transportation, conveyance, storage and installation .....	3-1
3.1 Precautions for transporting, moving and storing the pump .....	3-1
3.2 Before using the pump .....	3-1
3.3 Precautions for installation .....	3-2
3.4 Precautions for piping work .....	3-4
3.5 Precautions for wiring work .....	3-5
4. Operation.....	4-1
4.1 Check items before test operation.....	4-1
4.1.1 Check items related to the electrical system .....	4-1
4.1.2 Check items related to the pump.....	4-1
4.2 Running the pump (test operation).....	4-2
5. Maintenance and inspection.....	5-1
5.1 Precautions for maintenance and inspection .....	5-1
5.2 Mechanical seal.....	5-2
5.3 Daily inspection .....	5-2
5.4 Periodic inspection .....	5-2
6. Troubleshooting.....	6-1
7. After-sales service .....	7-1
8. Disposal.....	8-1
8.1 Precautions for disposal.....	8-1

# 1. Safety precautions

## 1.1 Types and meanings of warning terms and graphic symbols

This instruction manual divides precautions into the following four categories according to the level of hazards (or the severity of the accident). In addition, prohibited or mandatory actions as well as cautions are indicated with a graphic symbol.

Be sure to understand the meanings of the following terms and comply with the content (instructions) of the instruction manual.

### ■ Explanation of the warning terms

Warning Term	Meaning
<b>Danger</b>	Indicates an imminently hazardous situation. Failure to observe this will result in death or serious injury.
<b>Warning</b>	Indicates a potentially hazardous situation. Failure to observe this will result in death or serious injury.
<b>Caution</b>	Indicates a potentially hazardous situation. Failure to observe this will result in minor or moderate injury or property damage.
<b>Note</b>	Indicates information that is in particular to be noted or emphasized.













### ■ Explanation of the graphic symbols

















Don'ts	Do not touch	Do not disassemble	Do not touch with wet hand	Do not expose to water
These graphic symbols indicate prohibited actions (that must NOT be done).				
Do's				
Caution	Electric shock hazard	Rotation hazard	Hot surface	
These graphic symbols indicate existing hazards to beware of.				

















## 1.2 Safety precautions

<b>Danger</b>	
	Once the main power is turned on, do not touch any live parts. A high voltage applied to live parts may cause a serious electric shock, thus leading to death.
	Do not use the product in any explosive atmosphere. Otherwise, it may lead to an injury or fire.

<b>Warning</b>	
	Properly move the unit according to hoisting instructions. Otherwise, the unit may fall, thus leading to an injury or damage.
	Do not carry out any work with/on the pump that is being hoisted. Otherwise, the unit may fall, thus leading to an injury or damage.
	Only those who are authorized by the site manager are allowed to operate the pump. Operation by unskilled personnel may lead to an unforeseen accident.
	Installation, maintenance, and inspection must only be carried out by personnel who have been trained to handle the pump. Operation by unskilled personnel may lead to an unforeseen accident.
	Only qualified personnel, such as licensed electrical engineers, are allowed to carry out electric work. Otherwise, it may lead to an electric shock, fire, failure, or other problems.
	Use high-quality wiring equipment and devices, and carry out wiring work safely and securely according to the technical standards for electrical facilities, as well as the indoor wiring regulations. Otherwise, it may lead to an electric shock, fire, or other problems.
	Do not connect the ground wire to a gas pipe or water pipe. Such a connection is illegal and leads to an electric shock, explosion, or fire.
	Securely install the ground wire and ensure to carry out grounding work. Otherwise, it may lead to an electric leak or electric shock.
	Do not run the unit if abnormal condition is observed in any operation, movement, parts, etc. Otherwise, it may lead to an injury, failure, or various accidents.
	Correctly and securely connect the wires according to the wiring diagram within the terminal box and the instruction manual. Incorrect wiring may cause a fire, electric shock, failure, or other problems.

 <b>Warning</b>	
 Be sure to keep the terminal box cover attached during the operation of the pump. Otherwise, it may lead to an electric shock.	 Do not forcibly bend, pull, or pinch the power cable or any lead wires of the product. Otherwise, it may lead to an electric shock or fire.
 After detaching the companion flange from the pump, screw a pipe into it. Otherwise, it may lead to damage or leakage.	 Before starting the maintenance or inspection work, be sure to stop the pump and turn off the main power of the panel board. Otherwise, it may lead to an electric shock, injury, damage, or leakage.
 Check the wiring sections and wires for any looseness. A loose connection may cause a fire or electric shock.	 Before rotating the pump shaft by hand to check its smooth rotation, be sure to turn off the main power. Otherwise, it may lead to an injury or damage.
 Before starting the unit or carrying out maintenance/inspection work, ensure that all the relevant workers are informed of the operation and that there are no workers in the dangerous zone. Otherwise, it may lead to an unforeseen accident.	 [VKN-e] Do not perform zero-discharge operation. [VKP-e] Do not perform long hours of zero-discharge operation continuously. Otherwise, the temperature and pressure may increase inside the pump, thus damaging the pump or causing steam to blow off.
 After turning on the power, do not touch any parts of the pump other than those required for operation. Otherwise, it may lead to an electric shock or injury.	 For overhaul, replacement of parts, or repairs, ask the vendor or the service center specified by Teral. If unskilled personnel carry out work that requires special knowledge, it may lead to an accident or failure.
 Do not put your fingers or foreign objects into any openings or rotating part of the motor during operation. Otherwise, it may lead to an injury or damage.	 In the event of a power failure, be sure to turn off the power switch. Otherwise, the pump may suddenly start up on restoration of the power, thus leading to an injury.

 <b>Caution</b>	
 Do not use the unit outside the range of the product specifications. Otherwise, it may lead to an electric shock, fire, leakage, failure, or other problems.	 Do not use the unit at an incorrect power voltage. An incorrect voltage may damage the motor.
 Do not use a single pump unit as the only means of directly operating key facilities or sustaining life. In the event of a failure, the liquid supply may stop. Ensure to make a backup unit available for operation.	 Before unpacking the delivered container, check that the container is placed in the correct orientation (not upside down). Carefully unpack the container, while paying special attention to nails. Otherwise, it may lead to an injury or damage.
 Ensure that the floor at the unit's installation place is waterproofed and fitted with drainage. Otherwise, it may lead to serious damage in the event of leakage.	 Do not install two or more different cables or control wires in one pipe or duct. Otherwise, it may lead to malfunction of the product or other equipment.
 Do not step on the pump or motor. Otherwise, it may lead to an injury, damage, or other problems.	 Do not expose the motor to liquid. Otherwise, it may lead to an electric shock, electric leak, failure, or other problems.
 Operate the controls carefully. Otherwise, it may lead to an injury or damage.	 During test operation, never run the pump dry (i.e. never run the pump when the liquid level is below the Minimum liquid level). Otherwise, it may lead to damage or a fire.
 Before operation, thoroughly clean (flush) the inside of the piping to remove foreign matter. Otherwise, the piping system may be contaminated with foreign matter, thus leading to an accident or a pump failure.	 During normal operation, do not run the pump dry for more than 30 seconds. Otherwise, it may lead to damage or a fire.
 Do not put a cloth or other covering on the motor. Otherwise, it may lead to overheating or ignition.	 Do not touch the motor body while the pump is running or immediately after the pump has stopped. Otherwise, you may get burns from the hot surface.
 In the event of an alarm or abnormal condition that cannot be resolved, immediately stop the operation, turn off the power, and then contact Teral or its service provider. Otherwise, it may lead to an accident.	 Do not run the pump with tools or other objects placed on the unit. Otherwise, it may lead to an injury or damage.

 <b>Caution</b>	
 Check that the delivered items are exactly what you ordered. The use of a wrong product may cause an injury or failure.	 Do not place any combustibles around the product. Otherwise, it may lead to a fire.
 Do not place any obstacles around the product that may hinder ventilation. Otherwise, it may lead to a fire.	 Do not touch the impeller, tie bolt, or other parts of the pump with bare hands. Otherwise, it may lead to an injury or damage.
 Do not run the pump at a frequency exceeding 60 Hz. Otherwise, it may lead to motor burnout or a fire.	 Do not use the unit for pumping any fluids beyond the specified viscosity limit. Otherwise, it may lead to motor burnout or a fire.
 Ensure to install an overcurrent protective device. The user is required by the technical standards for electrical facilities to install one. Otherwise, it may damage the product, thus leading to a fire or failure. It is also recommended to install protective devices such as a ground fault interrupter.	 Do not touch any terminals or wires when measuring the insulation resistance. Otherwise, it may lead to an electric shock.
 Do not use thinner or benzene for cleaning the product. Otherwise, the product may be discolored or its coating may be peeled off.	 Once you turn off the power, wait until the pump stops completely. Do not restart the pump until it does. Otherwise, the main shaft may be subjected to an excessive load, which makes the service life of the pump shorter.
 When you hoist the product, pay attention to its center of gravity. Otherwise, the product may topple over or fall, thus leading to an injury.	 If you use a solvent for cleaning the product, pay attention to handling of the solvent as well as the environment of use. Otherwise, it may lead to poisoning.
 When you lift the product by hand, pay attention to its weight. Do not allow a single person to lift a product heavier than 15 kg. Otherwise, it may put strain on the body, thus leading to an injury.	 Dispose of the product as industrial waste.
 Be sure to conduct inspection according to the Maintenance checklist. Otherwise, you cannot prevent potential failures, thus leading to a higher risk of accidents.	 For star-delta starting, use a starter with an electromagnetic switch (three-contactor type) on the primary side. Otherwise, it may lead to a fire.

### 1.3 Location of warning labels and caution labels

The figure shows the locations of warning labels and caution labels. If these labels become dirty and illegible or if they are peeled off, replace them with a new one.

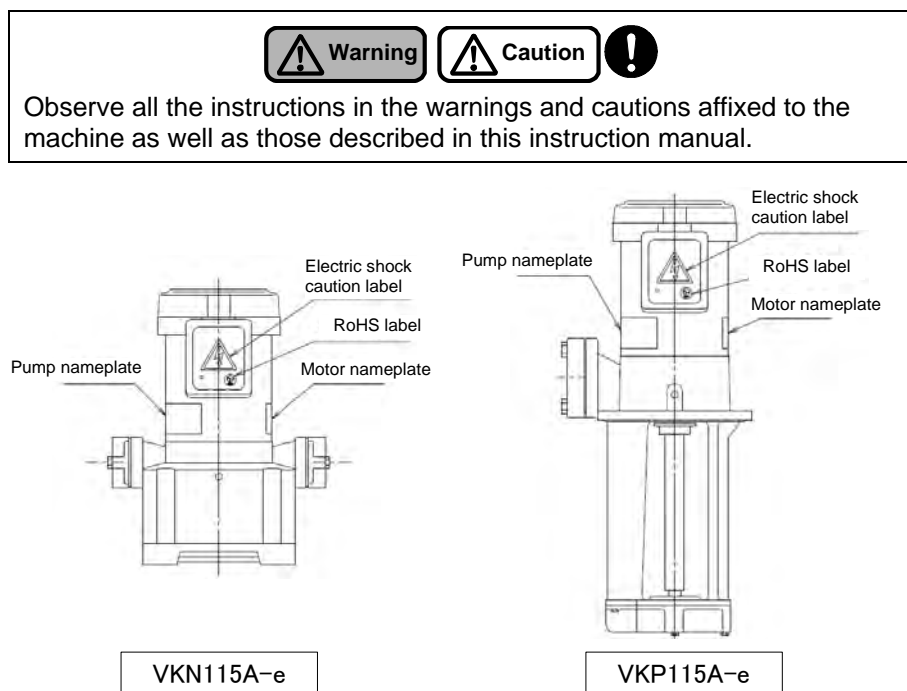

## 2. Configuration and overview of the pump

This chapter describes the standard specifications of the pump. For details, refer to the delivery specifications such as the dimensional outline drawing and the internal structure drawing. If you have purchased a customized product, some information in this chapter may not be applicable to your unit. See the dimensional outline drawing, the internal structure drawing, and other documents to check the product specifications in such a case.



Do not use this product under any conditions other than those provided in the specifications. Otherwise, it may lead to an electric shock, fire, leakage, or failure.

### 2.1 Part names and functions

- ① Motor
- ② Discharge port
- ③ Suction port

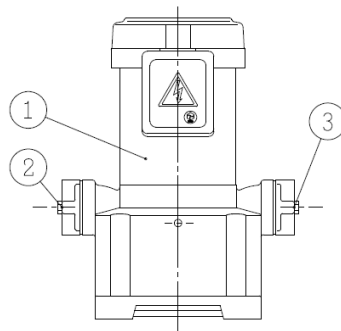

VKN115A-e

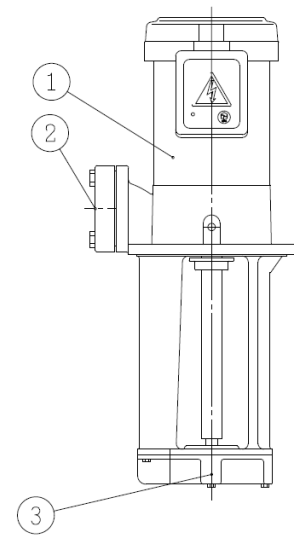

VKP115A-e

### 2.2 Naming rule of the model codes

**VKN 11 5 A -e**  
 ①    ②    ③    ④    ⑤

- ① Model
- ② Output code (11: 750W)
- ③ Series number
- ④ Phase and characteristics (A: 3-phase, flow rate type)
- ⑤ Top Runner Energy Efficiency Standards (IE3-equivalent) motor

**VKP 11 5 A -e**  
 ①    ②    ③    ④    ⑤

- ① Model
- ② Output code (11: 750W)
- ③ Series number
- ④ Phase and characteristics (A: 3-phase, flow rate type)
- ⑤ Top Runner Energy Efficiency Standards (IE3-equivalent) motor

## 2.3 Standard specifications\*

Model		VKN-e	VKP-e
Applicable liquid	Quality	Grinding fluid, cutting fluid, etc. <sup>Note 1</sup>	
	Temperature	40°C or lower (No frozen liquid is allowed.)	
	Dynamic viscosity	See "Note 2."	
Installation location		Indoors, Height above sea level: 1,000 m or less, Humidity: 85%RH or less (No condensation is allowed.), Place not exposed to direct sunlight, Place whose atmosphere contains no corrosive gas, explosive gas or vapor	
		Ambient temperature: 0 to 40°C	Ambient temperature: -20 to 40°C
Bore [Rp]		1 1/2	2
Max. suction pipe length <sup>Note 3</sup>		0.7 m or shorter	-
Material	Casing, pump leg	FC150/200	
	Impeller	CAC407	
	Motor main shaft	S45C	
Shaft sealing structure		Mechanical seal (carbon, ceramics)	-
Motor	Type	Totally-enclosed fan-cooled indoor type	
	IP protection	IP54	
	Power <sup>Note 4</sup>	3-phase 50/60Hz	200/200-220V
	Insulation class	Class F	
	Number of poles	2P	
	Standard	IEC60034-1	
Noise [dB(A)]		78	75
Coating color		Munsell N1	

Note 1 Note that the product cannot be used for water or special liquids such as printing liquids or acidic liquids.

Note 2 If you pump liquids with a dynamic viscosity beyond the limit specified in the following table, the service life of the motor may become shorter and the motor may burn out. Be sure to use a liquid with a dynamic viscosity below the limit specified in the following table. Note that a decrease in liquid temperature could significantly increase its dynamic viscosity. Before pumping a liquid, check its dynamic viscosity at the minimum liquid temperature. The characteristics of the pump deteriorate as an increase in the dynamic viscosity of the liquid.

Model	Maximum allowable limit of dynamic viscosity for liquids to be pumped [mm <sup>2</sup> /s]	
	Running at 50Hz	Running at 60Hz
VKN115A-e	200	75
VKP115A-e	300	150

Note 3 If the bore size is different from the standard size, the maximum suction pipe length is inversely proportional to the square of the bore size.

Note 4 Limit the fluctuations of the power voltage within  $\pm 10\%$  of the rated voltage, and also limit the fluctuations of the frequency between  $-5\%$  and  $+3\%$  of the rated value. Avoid continuous operation if the voltage is not within  $\pm 5\%$  of the rated value or if the frequency is not within  $\pm 2\%$  of the rated value.

\* This product is labeled with a self-declaration CE mark and complies with the Essential Safety Requirements (ESRs) of the "EU (EC) Directive." The following are the general descriptions.



Manufacturer	Teral Inc. 230 Moriwake, Miyuki-cho, Fukuyama-city, Hiroshima 720-0003 Japan
Product	VKN-e/VKP-e model coolant pump
Standards	Machinery Directive 2006/42/EC
	EN 809/A1:2009, EN ISO 12100:2010, EN 60204-1/A1:2009
Manufacturer (Japan)	Teral Inc., Hiroshima
Administrator (EU nations)	Shiran Tower 5F Luzna 716/2 160 00 Vokovice, Praha 6
	CZECH REPUBLIC Person in charge: Tomohisa Yamamoto
Place of declaration	Hiroshima, Japan Manager: Taiji Monden

#### 2.4 Information indicated on the nameplate

The specifications of the pump are indicated on the nameplate. Upon receiving the pump, check the nameplate to verify that the delivered product is exactly what you ordered. Be sure to confirm the model, motor output, frequency, and voltage. If there is anything different from what you ordered, contact the vendor from which you purchased the product. Do not remove the nameplate or place any obstacles in front of it. Always keep the nameplate clearly visible.



Do not run the pump at a frequency exceeding 60 Hz. Otherwise, it may lead to overload and burnout of the motor.

<b>TERAL</b>		COOLANT PUMP		CE	
		3-PHASE a. c. INDUCTION MOTOR			
TYPE	①	Hz	⑥		
OUTPUT	②	kW	VOLT	⑦	
PIPE SIZE	③	B	AMP	⑧	
HEAD	④	m	min <sup>-1</sup>	⑨	
Q' TY	⑤	L/min	Maximum safe operating speed	⑩	
Year of manufacture	⑪		BRG	D-END	⑬
Main document NO.	⑫			N-END	⑭
SER NO.	⑮				
230, Moriwake, Miyuki-cho, Fukuyama-city, Hiroshima, 720-0003, Japan		TERAL INC.		M-6521-*	

Pump nameplate

No.	Item
1	Model
2	Motor output (kW)
3	Discharge bore (B)
4	Total head (m)
5	Discharge rate (L/min)
6	Frequency (Hz)
7	Voltage (V)
8	Current (A)
9	Rotation speed (min <sup>-1</sup> )
10	Max. allowable rotation speed (min <sup>-1</sup> )
11	Year of manufacture
12	Instruction manual No.
13	Inboard bearing type
14	Outboard bearing type
15	Serial number

## 2.5 Specification table

### • Model VKN-e

Specifications \ Model	VKN115A-e	
Output (W)	750	
Rated voltage (V)	200	200 220
Frequency (Hz)	50	60
Rated electric current (A)	3.3	4.5 4.2
Starting electric current (A)	34.0	32.5 36.0
Discharge rate (L/min)	230	320
Total head (m)	7	
Maximum allowable limit of dynamic viscosity [mm <sup>2</sup> /s]	200	75

Note 1) The discharge rate and the total head are values when the model is tested at a dynamic viscosity of 1 mm<sup>2</sup>/s (the same viscosity as fresh water at normal temperature). Note that this model cannot be used to pump water.

Note 2) The rated electric current in the above table (current value indicated on the pump nameplate) is the recommended preset current value of the protective device.

### • Model VKP-e

Specifications \ Model	VKP115A-e	
Output (W)	750	
Rated voltage (V)	200	200 220
Frequency (Hz)	50	60
Rated electric current (A)	3.3	3.7 3.6
Starting electric current (A)	34.0	32.5 36.0
Discharge rate (L/min)	165	285
Total head (m)	7	
Maximum allowable limit of dynamic viscosity [mm <sup>2</sup> /s]	300	150

Note 1) The discharge rate and the total head are values when the model is tested at a dynamic viscosity of 1 mm<sup>2</sup>/s (the same viscosity as fresh water at normal temperature). Note that this model cannot be used to pump water.

Note 2) The rated electric current in the above table (current value indicated on the pump nameplate) is the recommended preset current value of the protective device.

## 2.6 Dimensional outline drawing

### • VKN115A-e

Approx. weight: 29kg

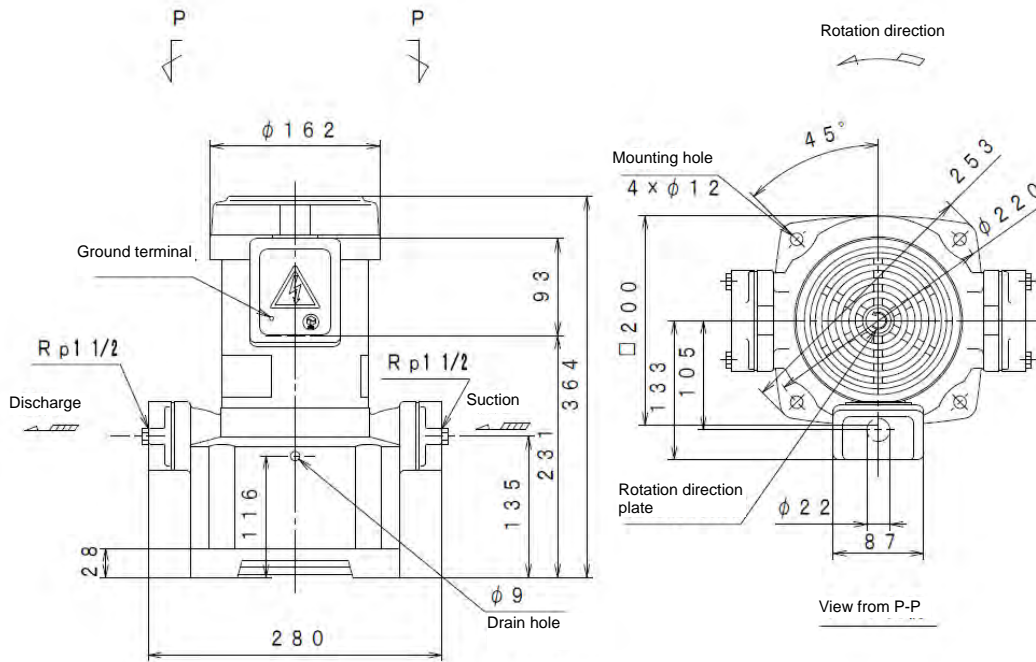

### • VKP115A-e

Approx. weight: 30kg

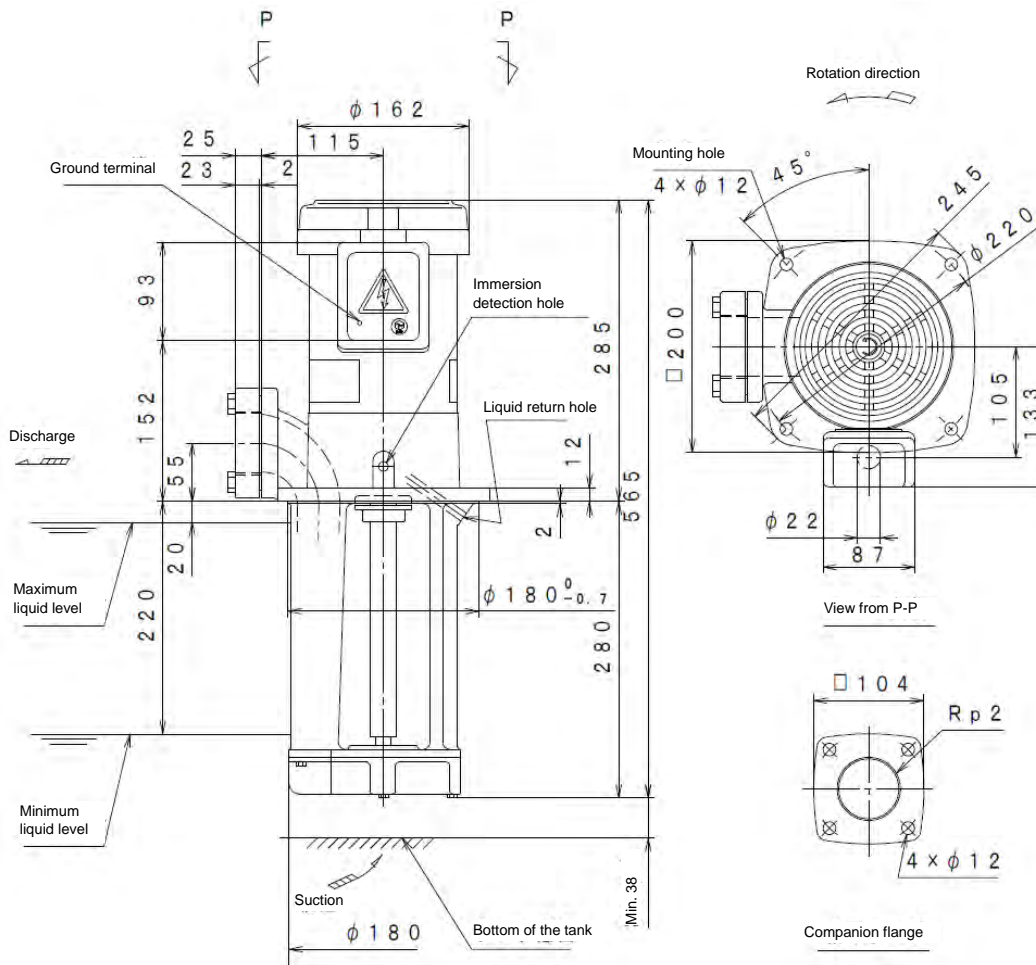

## 2.7 Internal structure drawing

### • VKN115A-e

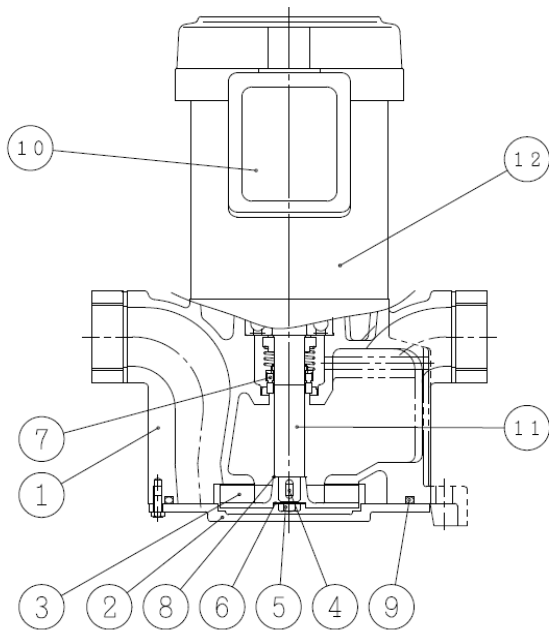

No.	Part name	Material
1	Casing	FC150/200
2	Base plate	FC150/200
3	Impeller	CAC407
4	Key	S45C
5	Hexagon head bolt	SS
6	Washer	SS
7	Mechanical seal	Ceramics, Carbon
8	Adjusting piece	BsP3-1/2H
		Phosphor bronze
9	O-ring	NBR
10	Terminal box	SPCC
11	Motor main shaft	S45C
12	Motor	-

### • VKP115A-e

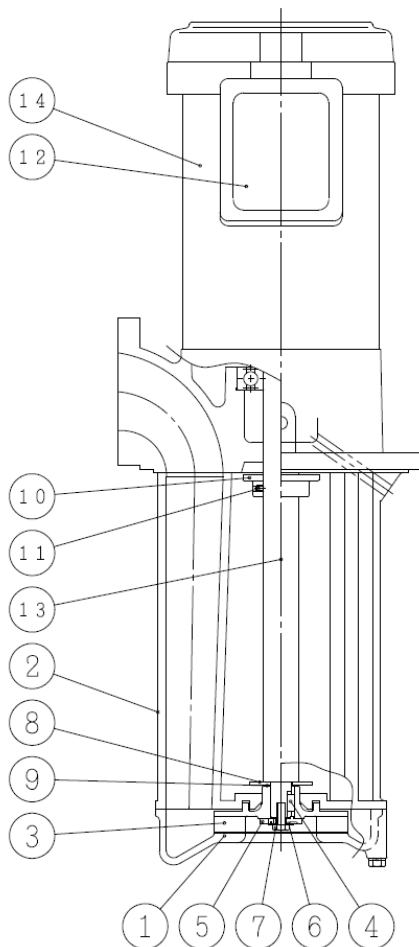

No.	Part name	Material
1	Spiral box	FC150
2	Pump leg	FC150/200
3	Impeller	CAC407
4	Key	S45C
5	Pressing washer	SPCC
6	Claw washer	SPCC
7	Impeller pressing bolt	SS
8	Deflector	SPHC
9	Adjusting piece	BsP3-1/2H
		Phosphor bronze
10	Collar	FC150/200
11	Hexagon socket head set screw	SS
12	Terminal box	SPCC
13	Motor main shaft	S45C
14	Motor	-

### 3. Transportation, conveyance, storage and installation

#### 3.1 Precautions for transporting, moving and storing the pump

- (1) Do not unpack the container unnecessarily.  
If you unpack the container unnecessarily, securely pack again in such a manner that the product body does not jump out of it and fall down during transportation, conveyance or storage
- (2) When you transport, move, or store the pump, ensure that the pump is located in a well-ventilated place with minimum exposure to dust and moisture in an environment at an ambient temperature of -25 to 55 degrees Celsius and humidity of lower than 85%RH. The packing materials, made mainly of corrugated cardboards, break more easily when they absorb moisture.
- (3) Check the orientation of the container and then place it in the correct orientation (not upside down).
- (4) Do not stack the containers of the product more than the allowable number of units indicated on the packing material.  
The maximum allowable number of stacks for this product is four.
- (5) Use extreme care so as not to give an impact or offset load to the pump during conveyance or transportation. The container may greatly incline depending on its center of gravity.



Before transporting or moving the product, confirm the weight of each unit by referring to the catalog, dimensional outline drawing, and other documents, and then determine the appropriate method.



When you lift the product by hand, pay attention to its center of gravity and weight. Do not allow a single person to lift a product heavier than 15 kg. Otherwise, it may put strain on the body, thus leading to an injury.

#### 3.2 Before using the pump

Upon receiving the pump, check the following points first.  
If you find any problems, contact the vendor from which you purchased the product.

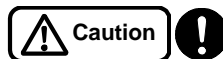

Before unpacking the delivered container, ensure that the container is placed in the correct orientation (not upside down). Pay special attention to nails especially when opening a wooden crate. Otherwise, you may get injured.

- (1) Check the nameplate to verify that the delivered product is exactly what you ordered. (Refer to 2.4. Information indicated on the nameplate. [page 2-3].)
- (2) No part of the product is damaged during transportation.
- (3) All fastening parts including bolts and nuts are securely tightened.
- (4) All the accessories that you ordered have been delivered.



Do not run the pump at a frequency exceeding 60 Hz. Otherwise, it may lead to overload and burnout of the motor.

### 3.3 Precautions for installation

[VKN-e/VKP-e]



**Warning**

Before rotating the pump shaft by hand to check it, be sure to turn off the main power. An unexpected start of the pump may cause an accident.

- (1) Install the product in a well-ventilated place with minimum exposure to dust and moisture. (Refer to the Installation location in “2.3. Standard specifications [page 2-2]”). In particular, avoid installing the product in a place where the pumping liquid may be splashed on the motor section.



**Warning**

Do not install the product in a hot or humid place. Otherwise, it may lead to heating, ignition or electric leak.

- (2) Install the product so that the motor can take air in.
- (3) Securely install the product on a flat place without any wobbles.
- (4) The mounting surface must be strong enough to prevent the amplification of vibrations while the pump is running.  
(Restrict the total amplitudes in X, Y, and Z directions (see the right figure) to 33 $\mu$ m at 50 Hz and to 29 $\mu$ m at 60 Hz during the operation of the pump.)

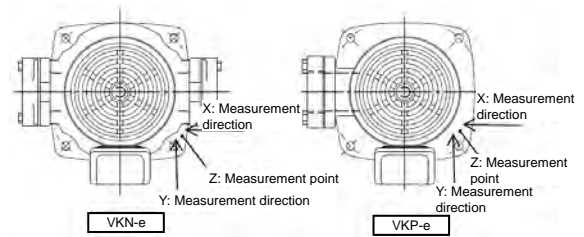

- (5) Select a convenient place to conduct maintenance and inspection. Secure space for maintenance.
- (6) The product is coated. If you need to overcoat it in a different color for a compelling reason, lightly roughen the product surface with sand paper or the like and then coat it, which improves the adhesion properties of the coating film. (Be sure to check the overcoatability of the paint.)

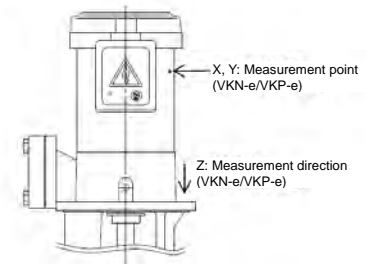

- (7) Do not install the product in a place where a secondary hazard could occur in the event of any liquid leak.
- (8) If the system could be exposed to the freezing temperature in winter, be sure to apply antifreeze measures such as heat insulation and heater installation to the pump, valves, piping, etc.
- (9) Securely install the pump.  
Recommended size of pump mounting bolt: M10

The pump is provided with four mounting bolt-holes, but they are intended to extend the range of use. You can install the pump using only two diagonally-located mounting holes without any problems.

**Note**

Securely fix the pump in place with the bolts. Otherwise, it may lead to abnormal vibration or other problems.

- (10) Do not hoist the equipment with the pump attached. Otherwise, it may damage the hoisting equipment/devices and the pump may fall.
- (11) When you hoist or move the pump, be sure to handle the pump carefully so that the pump section would not be subjected to an impact or imbalanced load. The container may greatly tilt depending on its center of gravity.



Before hoisting the pump, refer to the catalog, dimensional outline drawing, and other documents to check the weight of the units. Do not hoist any units if its weight exceeds the rated load of the hoisting equipment/devices.

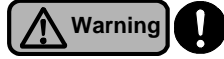

Never use a pump that is being hoisted or install parts on it. Otherwise, the pump may fall.



When hoisting the pump, pay attention to its center of gravity. Otherwise, the pump may topple over or fall, thus leading to an injury.



When you lift the product by hand, pay attention to its center of gravity and weight. Do not allow a single person to lift a product heavier than 15 kg. Otherwise, it may put strain on the body, thus leading to an injury.

- (12) If the pumping liquid is cold, condensation may occur inside the motor while the pump is stopped. Take measures to prevent condensation, for example, by installing the pump in a sufficiently dry room or by heating and insulating the motor even when the pump is stopped.
- (13) Carry out touchup painting at a time interval suitable for the environment of use. Depending on the humidity, condensation, and other conditions, rust may form on areas such as threaded parts, worked areas, anticorrosive-coated sections.
- (14) Do not put a cover or filter over the motor. Otherwise, the temperature may increase inside the motor, thus leading to an unexpected failure.

[VKN-e]

- (15) Install the pump at a place as close to the oil tank as possible with its suction height as low and its suction pipe length as short as possible. In addition, do not install the pump at a position lower than the liquid level, at a slanted posture, or with the shaft being horizontal, as shown in the right figure.

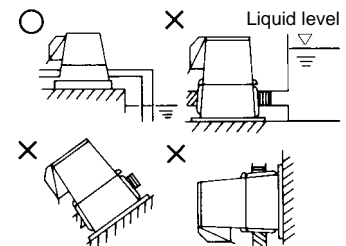

- (16) If the shaft sealing device (mechanical seal) is worn or damaged, the liquid leaking from the shaft sealing device will be discharged from the drain to protect the motor. If the discharged liquid may cause problems such as contamination around the unit, take appropriate measures in advance.

- (17) When you hoist the pump, wind the rope or the like around the casing (just below the suction port and discharge port) and lift it. Pay attention not to allow the pump to slip out of the rope and fall.

[VKP-e]

- (18) It is necessary to make a mounting hole larger than the outside diameter of the pump section so that the pump section can fit into the tank (oil tank). See the dimensional outline drawing.
- (19) Install the pump so that its main shaft is located in a vertical position.
- (20) For the operation, the pump section needs to be submerged below the liquid level. Because the suction port is located at the bottom, keep the suction port at least 38 mm away from the bottom surface of the tank (oil tank) to prevent the strainer from getting clogged with cutting powder, dirt, or other materials. If cutting powder, dirt, or other materials are predicted to accumulate on the bottom of the tank, provide as large a distance as possible from the bottom at the design stage.

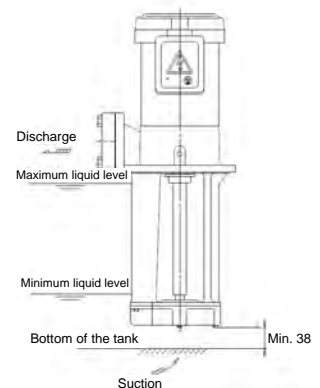

**Note**

Always keep the liquid level in the tank (oil tank) above the Minimum liquid level.  
Keep the suction port of the pump at least 38 mm away from the bottom of the tank (oil tank).

- (21) To hoist the pump, install an eyenut and a hexagon head bolt at two (diagonally-located) mounting holes of the pump, and pass a rope or the like through the eyenuts.

Eyenut size: M10,

Bolt size: M10 x 25L (nominal length [length below the head]: 25 mm)

- (22) Before installing the pump to equipment, place crossties (with enough height to remove the hexagon head bolts) between the pump flange surface and pump mounting surface as shown in the right figure, and remove the eyenuts and hexagon head bolts installed for hoisting. Afterwards, pull out the crossties and install the pump.

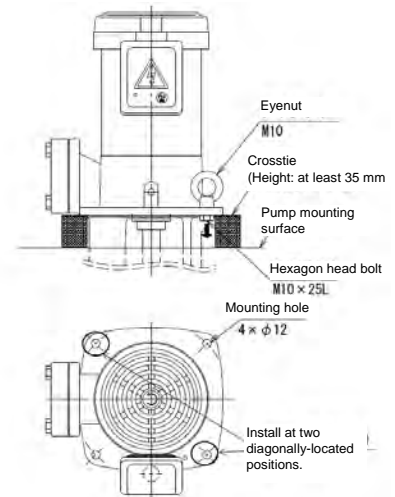

When installing the pump, do not put your hands between the pump flange and the pump mounting surface. Otherwise, it may lead to an injury.

### 3.4 Precautions for piping work

- (1) The pipes must be as short and straight as possible with minimal joints and valves. Use pipes whose bore size is equal to or larger than the discharge port of the pump. If the piping size is small or there are many bends, the discharge rate may become low.
- (2) Ensure to provide adequate pipe supports so that the weight of the piping system will not be applied directly to the pump body.



Do not allow the weight of the pipes to rest on the pump. Otherwise, the main shaft may be displaced from the center, thus leading to equipment damage, vibration, or noise.

- (3) Do not forcibly screw a pipe into the pump. Otherwise, it may break the joint.
- (4) Securely connect the pipes so that the connections are kept completely airtight without leakage. Prevent leaks of liquid and air with seal tape, liquid packing, or other means. Firmly wind the seal tape while paying attention not to block the piping.
- (5) Use a tank (oil tank) with as large a capacity as possible.  
\* It is recommended to use a capacity of at least three times the discharge volume per minute. Too small a capacity may cause problems such as the rise of liquid temperature, pump damage caused by the suction of cutting powder etc., and lower discharge rate caused by bubbles. When you supply a pumping liquid into a tank (oil tank), gently pour it to prevent the introduction of air.
- (6) Do not allow a large amount of cutting powder, dirt, or other contaminants from entering the pump section. Otherwise, it may damage the pump or significantly deteriorate the performance. Pass liquids through a net cage, chip conveyor, magnetic separator, or other devices and treat them according to the following table before supplying them to any coolant pumps for use.

Pumps that can be used for liquids after the primary treatment	Model VKP-e
Pumps that can be used for liquids after the secondary treatment	Model VKN-e



- (7) If water hammer may occur, attach a pressure damper (e.g. accumulator).
- (8) Observe the following points when installing the suction pipe for the model VKN-e.

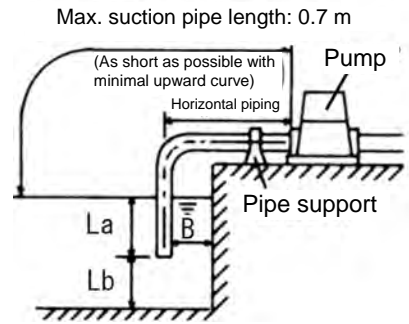

- ① Do not allow the suction pipe to exceed 0.7 m in length including its horizontal piping section. If you need to install a longer suction pipe for a compelling reason, provide a check valve with small head loss at the end of the suction pipe.
- ② Provide a sufficient distance from the end of the suction pipe to the liquid level (La in the figure) and to the wall of the tank (oil tank) (B in the figure). If the end position is too shallow or too close to the wall, vortex may be formed, thus leading to the suction of air, making it impossible to pump the liquid, or causing vibrations and noise.
- ③ Provide a sufficient distance from the end of the suction pipe to the bottom surface of the tank (oil tank) (Lb in the figure). If the end position is too close to the bottom surface, it may lead to suction failure or the suction of foreign matter such as cutting powder.
- ④ To prevent the formation of air pockets inside the pipe, provide a rising slope leading up to the pump.

- (9) If there is an upward curve on the discharge pipe, ensure that air can be vented from the section.
- (10) If you provide a relief pipe on the discharge side of the pump, also provide a sluice valve in the middle of the relief pipe to adjust the relief volume.

**Note**

If the amount of liquid released from the relief pipe is too much, the liquid temperature easily rises in the tank (oil tank).

- (11) On completion of the piping work, be sure to clean the tank (oil tank). Pay attention not to contaminate the system with foreign matter.

### 3.5 Precautions for wiring work

**Danger** ! ⚡

Use high-quality wiring equipment and devices, and carry out wiring work safely and securely according to the technical standards for electrical facilities, as well as the indoor wiring regulations. Only qualified personnel such as licensed electrical engineers are allowed to carry out electrical wiring work. Unqualified persons are prohibited by law to carry out wiring work, and it is very dangerous.

**Danger** ! ⚡

Securely connect the terminals of the power cable. Loose terminals may cause the motor to run in open-phase condition, thus leading to motor burnout.

- (1) For the size of the power cable, refer to the following:

Model	Minimum size of the cable (200-volt class)
VKN115A-e, VKP115A-e	1.6 mm

- (2) Be sure to install a ground fault interrupter and an overload protection device on the primary power side of the pump.
  - \* The starting current of Top Runner Energy Efficiency Standards (equivalent to IE3) motor-equipped products tends to become higher than that of standard efficiency (IE1) motor-equipped products. Therefore, when you switch from an IE1 motor-equipped product, it is necessary to verify the applicability of its ground fault interrupter and overload protection device.

Refer to the “Starting electric current” and “Rated electric current” specified in “2.5. Specification table [page 2-4].” If you have any questions, contact Teral.

**Note**

When you switch from an IE1 motor-equipped product, it is necessary to verify the applicability of its protection device on the primary side of the pump.  
Otherwise, the protective device may be tripped on startup.

- (3) Securely connect to the power by wiring the terminals according to the right figure (standard voltage product).  
\* If there are four or more terminals, follow the connection nameplate in the terminal box.
- (4) Be sure to attach a ground wire to prevent an electric shock.  
Connect the ground wire to the ground terminal inside the terminal box of the motor.

(Standard voltage product)

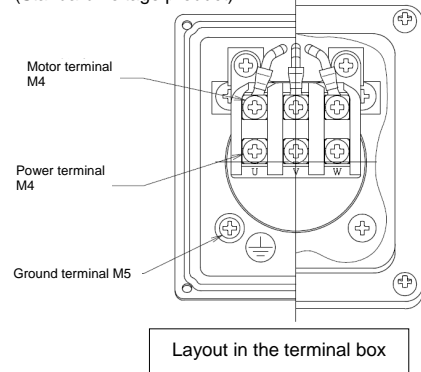

Connecting a ground wire to a gas pipe or water pipe is illegal and extremely dangerous.

- (5) To prevent the terminal block of the motor from being pulled, fasten the power cable to the terminal box with the cable lock.
- (6) The position of the terminal box relative to the discharge port can be changed in steps of 90 degrees by rearranging the frame of the motor. For how to rearrange the frame of the motor, contact Teral.
- (7) By rearranging the frame of the motor, you can change the external wiring hole of the terminal box in steps of 90 degrees (top, bottom, left, or right position). Note that, if you set the external wiring hole to the top, left, or right position, take adequate dust-proofing and drip-proofing measures using a connector, gland, or other means to prevent cutting powder and liquid from entering the terminal box.
- (8) To prevent overload and burnout of the motor, it is recommended to use a thermal relay for motor protection. For the recommended preset current, refer to the rated current shown in “2.5. Specification table [page 2-4].”
- (9) Take adequate dust-proofing and drip-proofing measures using a connector, gland, or other means to prevent any cutting powder and liquid coolant from entering the terminal box through the external wiring hole.
- (10) Pass the power cable through a metal tube or a metal conduit for shielding, and connect a ground wire to the outer surface of the tube.
- (11) Limit the fluctuations of the supply voltage within  $\pm 10\%$  of the rated voltage, and also limit the fluctuations of the frequency between  $-5\%$  and  $+3\%$  of the rated value. Although you can run the pump in these ranges, avoid continuous operation if the voltage is not within  $\pm 5\%$  of the rated value or if the frequency is not within  $\pm 2\%$  of the rated value. Otherwise, it may overload the pump, thus leading to motor damage or a fire.  
Even if the power fluctuations fall within the allowable ranges, the pump characteristics, motor characteristics, and the temperature rise of the motor may differ from those at the rated voltage and frequency.
- (12) Precautions for using the inverter drive
  - Ensure that the electric current during operation does not exceed 90% of the rated value.
  - Ensure that the minimum frequency is set to 20Hz.  
(Contact us if you need to run the drive at 20Hz or lower.)
  - Contact us when using a 400V class model. Protective measures may be required against inverter surge.
  - An inverter-driven motor generates a magnetic sound which may be annoying compared with the drives using commercial power supply. Although this magnetic sound does not cause an adverse effect on the quality of the motor, some inverters allow the user to adjust the tone by changing the carrier frequency. However, changing the frequency may reduce the allowable

- output of the inverter. Pay particular attention when selecting the inverter.
- If the pump and motor produce resonance during normal operation, do not run them in the range of the rotation speed.

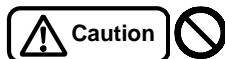

Do not run the pump at a frequency exceeding 60 Hz. Otherwise, it may lead to overload and burnout of the motor.

## 4. Operation

### 4.1 Check items before test operation

#### 4.1.1 Check items related to the electrical system

- (1) Check that the equipment is correctly wired.
- (2) Check that the terminals are securely connected.
- (3) Check that the equipment is securely grounded.
- (4) Check that the setup value of the overload protection device is consistent with the rated current value of the motor.



Do not use the product at any voltage other than the rated value. Otherwise, it may lead to a fire or electric shock.

#### 4.1.2 Check items related to the pump



Do not allow a large amount of foreign matter from entering the pump. Otherwise, it may damage the sliding parts (e.g. bearings, mechanical seal) inside the pump, or lead to leakage or unusual noise.

- (1) For the model VKN-e, be sure to prime the pump when you start up the model for the first time after installation or when you run the model after long periods of shutdown. The priming must be carried out from the discharge side until air inside the pump is completely removed (until no air comes out of the end of the suction pipe). Running the system with incomplete priming may make it impossible to pump up the liquid or damage the shaft sealing device. Note that if the length (H in the right figure) from the feed port of priming liquid to the pump discharge port is shorter than the length (L) of the suction pipe below the liquid level, you may not be able to fill the pump with liquid completely. In such a case, provide an air vent port for priming to the suction pipe or set the feed port of priming liquid at a sufficiently high position.

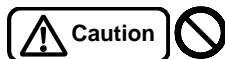
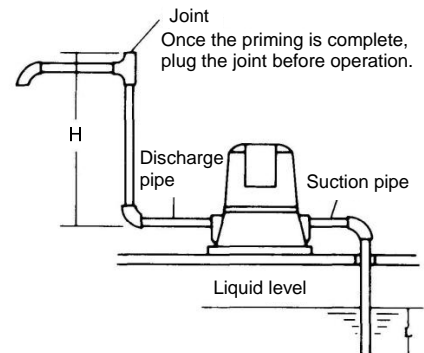

During test operation, never run the pump dry (i.e. running the pump when the liquid level is below the Minimum liquid level). During normal operation, do not run the pump dry for more than 30 seconds. Otherwise, it may seize up the sliding parts (e.g. bearings, mechanical seal) inside the pump.

- (2) For the model VKP-e, check that the liquid level in the tank (oil tank) is above the "Minimum liquid level."
- (3) Check the rotation direction. Normal rotation is counterclockwise when viewed from the motor side. (See the right figure.)
- (4) Rotate the main shaft by hand to check smooth rotation. To rotate the shaft by hand, insert a flat-blade screwdriver through the fan cover of the motor and turn its shaft. If the rotation is stiff or not uniform, there may be some rust or foreign matter inside the pump. Inspect the pump in such a case.

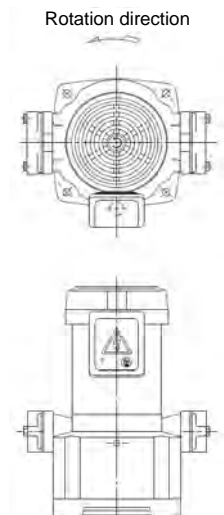



Before rotating the pump shaft by hand to check it, be sure to turn off the main power. An unexpected start of the pump may cause an accident.

- (5) If you run the motor at variable speed with the inverter, be sure to check the following points through test operations.
- The pump may produce resonance depending on installation conditions. If the pump produces resonance, avoid that frequency.
  - If the operation frequency is low or the dynamic viscosity of the pumping liquid is high, the pump may not discharge any liquid.
  - Do not run the pump at a frequency exceeding 60 Hz. Otherwise, the motor may burn out.



Do not run the pump at a frequency exceeding 60 Hz. Otherwise, it may lead to overload and burnout of the motor.

#### 4.2 Running the pump (test operation)



Be sure to attach the cover of the terminal box of the motor. Otherwise, it may lead to an electric shock.



Do not operate the pump if any abnormal condition is observed or if there is anything wrong with the parts, components, and others during the check before test operation. Otherwise, it may lead to an injury, failure, accident, or other problems.



If you pump a liquid above 40°C, do not touch the pump. Otherwise, its hot surface may cause burns.

- (1) Check the rotation direction of the pump by turning on and off the power switch once or twice. Normal rotation is counterclockwise when viewed from the motor side. If the pump rotates in reverse, swap two of the three wires of the power cable.

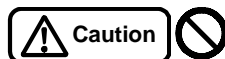

Never check the rotation direction by running the pump dry even for a short time. Otherwise, it may damage the sliding parts (e.g. mechanical seal, bearings) in the pump, or lead to leakage or unusual noise.

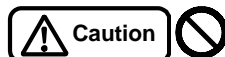

Do not run the motor in reverse because it may cause a failure.



Do not run the pump dry, and do not allow a large amount of air or foreign matter from entering the pump. Otherwise, it may damage the sliding parts (e.g. mechanical seal, bearings) in the pump, make it impossible to pump up liquid, or lead to leakage or unusual noise. It may also heat the pump, thus leading to burns.

- (2) Turn on the power to start the pump.
- (3) During the initial period of pump operation and circulation, gradually open the sluice valve on the discharge side to circulate liquid at a flow rate (flow velocity) higher than the normal operation.
- (4) Adjust the sluice valve on the discharge side so that the specified pressure is achieved.
- (5) The following are the instructions on zero-discharge operation, which runs the pump with the sluice valve shut.

[Model VKN-e]

Do not perform zero-discharge operation. Otherwise, it may increase the liquid temperature in the pump and damage the mechanical seal. If you need to perform zero-discharge operation for a compelling reason, allow a small amount of liquid to flow (at least 3L/min), for example, by providing a bypass circuit. If you no longer use the liquid, stop the pump.

[Model VKP-e]

Although running the pump with the sluice valve shut does not cause the overload of the motor, long hours of continuous operation in the condition increase the liquid temperature in the pump. Therefore, allow a small amount of liquid to flow (at least 3L/min); or if you no longer use the liquid, stop the pump. Too hot liquid may reduce the service life of the motor or damage the shaft seal.



[Model VKN-e] Do not perform zero-discharge operation.  
[Model VKP-e] Do not perform long hours of zero-discharge operation continuously. Otherwise, the liquid temperature may increase in the pump, thus leading to an unexpected failure.

- (6) When the liquid level is too low for the model VKP-e, the pump may take air in and decrease the discharge rate, thus making it impossible to pump the liquid. Keep the liquid level above the Minimum liquid level indicated in the Dimensional outline drawing. Note that, however, this liquid level changes depending on the viscosity and liquid surface condition. For safety, set the liquid level high enough, but at a level below the "Maximum liquid level" indicated in the outline drawing.
- (7) As a guide, limit the frequency of the startups and shutdowns to about 60 times or less per hour.

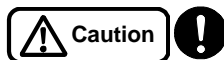

Minimize the frequency of startups and shutdowns of the pump because their high frequency may quickly damage the pump. Do not start the pump more than 60 times an hour or so.

- (8) In the event of a power failure during operation, be sure to turn off the power.



In the event of a power failure, be sure to turn off the power switch. Otherwise, the pump may suddenly start up on restoration of the power, thus leading to an injury.

- (9) Before restarting the pump, confirm that the pump has stopped completely.



**Caution** 

Before restarting the pump, be sure to check that the pump has stopped completely. Turning on the power while the pump is still rotating causes an excessive torque on the pump and may cause a failure.

- (10) Avoid sudden pressure fluctuations during the operation of the pump.
- (11) Check for any abnormal pressure, electric current, vibration, noise, and other abnormal conditions. If you find any abnormal conditions, take appropriate actions after consulting the Section “0.”
- (12) Troubleshooting (page 6-1).  
Refer to the following chart for vibration vs. rotation speed.

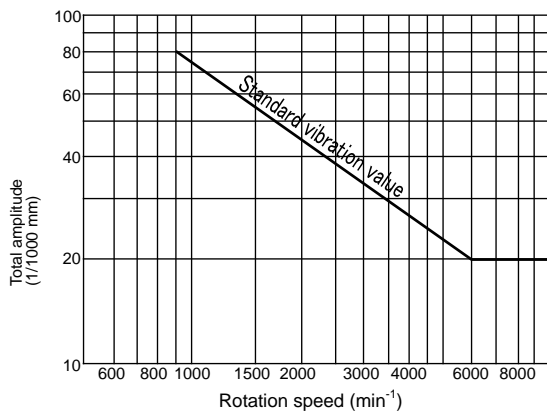

[For reference only]

Relation between the total amplitude (a) and the vibration velocity (V)

$$a = \frac{V \times 4 \times 10^4}{\pi \times n}$$

a: Total amplitude (μm)  
V: Vibration velocity (mm/s)  
n: Equipment rotation speed (min<sup>-1</sup>)

Standard vibration value at the bearing section

- (13) Do not allow a large amount of cutting powder from entering the pump. Otherwise, it may clog the pump strainer, damage the pump, or significantly deteriorate the performance. If you use the pump in processes such as grinding, milling, or end milling in which a large amount of cutting powder is discharged, select the pump carefully.
- (14) Stop the pump.



**Caution**

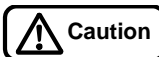

Keep the cocks of the pressure gauges, compound pressure gauges, and other parts closed all the time except when they are used for measurement. Otherwise, they are more prone to fail.



**Caution** 





Do not run the pump using the power beyond the allowable current value. Otherwise, the motor may burn out. For the allowable current value, see the characteristic curve.





**Warning**  

Do not put your fingers or other objects into the opening of the motor. Otherwise, it may lead to an electrical shock or injury.

## 5. Maintenance and inspection

 Warning   

Before checking the pump, be sure to turn off the main power. Otherwise, the pump may suddenly start up in automatic mode or on other occasions, thus leading to great danger.

 Warning 

Before starting the unit or carrying out maintenance/inspection work, ensure that all the relevant workers are informed of the operation and that there are no workers in the dangerous zone.

 Caution

For overhaul, replacement of parts, or repairs, ask the vendor or the service center specified by Teral. Incorrect work may cause a failure or accident.

### 5.1 Precautions for maintenance and inspection





(1) Observe the following points, in particular, during daily inspection.

- ① A large deviation in the pump's discharge pressure, electric current, vibration, noise, or other conditions from the normal status is a sign of a failure. Therefore, immediately take measures, referring to the Maintenance checklist in Section "5.4. Periodic inspection [page 5-2]." For this purpose, it is recommended to keep an operation log.
- ② If the bearing temperature gets abnormally high, immediately stop the pump and check the bearing. The temperature is normal if the temperature difference between the motor surface and the atmosphere does not exceed 40°C.
- ③ Because prelubricated shielded bearings are used, there is hardly any need for maintenance of the bearings such as refilling of grease. Replace the bearings if they generate unusual noise or vibration.

Model	Bearing type	
	Load side	Non-load side
VKN115A-e, VKP115A-e	6305ZZ	6203ZZ

\* Urea grease is adopted for lubrication inside the bearings to extend their service life. Use bearings into which urea grease is filled.

- ④ High-frequency sound (mechanical squeak) may occasionally be generated from the shaft seal, but it is not a pump failure. You can continue to use the pump with the same good quality.
- ⑤ Normally, liquid leakage hardly occurs at the mechanical seal of the shaft seal. If by any chance the liquid leakage becomes frequent, replace the seal.
- ⑥ Keep the cocks of the pressure gauges and compound gauge closed all the time except when inspection is required.
- ⑦ In the event of a power failure, be sure to turn off the power. The pump suddenly starts on restoration of the power, thus leading to danger.

 Warning   

In the event of a power failure, be sure to turn off the power switch. Otherwise, the pump may suddenly start up on restoration of the power, thus leading to an injury.

(2) If you do not use the pump for a long time, observe the following points:





If you do not use the pump for a long time, turn off the power for safety. Otherwise, accumulated dust may cause heating or ignition.

- ① To prevent possible freezing inside the pump in winter, be sure to take antifreeze measures—such as heat insulation or the installation of a heater to the pump—or completely drain the pump.
- ② The sliding surface of the mechanical seal may become stiff, which makes it difficult to rotate the shaft smoothly. Therefore, periodically run the pump to maintain smooth rotation. Moreover, before running the pump, turn it by hand to check that the rotation is smooth.



Before rotating the pump shaft by hand to check it, be sure to turn off the main power. An unexpected start of the pump may cause an accident.

- ③ If you have a backup pump, run it from time to time to make it available for operation at any time.

## 5.2 Mechanical seal

- (1) The mechanical seal is a precision part for preventing liquid leakage from the clearance of the pump shaft. Carefully handle the seal to ensure the proper operation of the pump.
- (2) The mechanical seals are consumables. They wear at a different rate depending on the properties of circulating liquid, the presence of foreign matter, operating pressure, and other factors; and the service life changes accordingly.
- (3) If there is any liquid leakage at the seal, replace it.
- (4) During the initial period of running a new pump, a small amount of leak may occur until the sliding surfaces on the mechanical seal completely settle (or fit) into place, but the leak should stop in several hours of operation. Since this initial leak does not mean a defect of the mechanical seal, you can normally use the pump.

## 5.3 Daily inspection

Upon startup and during operation, check the pump for any abnormal conditions in terms of its discharge pressure, electric current, vibration, noise, and others.

## 5.4 Periodic inspection

- (1) Clean any dirt, oil, and other deposits off the outer surface of the coolant pump.
- (2) Cutting powder deposited in the tank (oil tank) may cause a pump failure. Periodically clean the tank (oil tank).
- (3) For other inspection items, refer to the Maintenance checklist on the next page.

### Maintenance checklist

Item	Inspection point	Inspection item	Inspection method	Criterion (Reference page)	Inspection interval				Timing of replacing consumables (as a guide)* <sup>1</sup>
					Daily	Monthly	Half-yearly	Yearly	
Ambient conditions	Temperature	Check against the specified range.	Measure	Model VKN-e: Between 0 and 40°C Model VKP-e: Between -20 and 40°C (2-2)	✓				-
	Humidity		Measure	85%RH or less(2-2)	✓				-
	Dust and other contaminants		Visual check	No dust or other contaminants	✓				-
Power	Power terminal block	Voltage	Measure	Specified voltage (2-2)			✓		-
		Voltage fluctuation	Measure	Within the allowable fluctuation range (2-2)			✓		-
		Loose screws	Tighten	Securely tightened				✓	-
Pump and motor	Impeller	Clogging	Disassemble and inspect	No clogging				✓	-
		Wear	Disassemble and inspect	No abnormal condition				✓	When worn out
	Main shaft and its surrounding area	Smooth rotation	Rotate by hand	Rotation is smooth and uniform (4-1)				✓	-
	Bearing (motor) <sup>*2</sup>	Heat	Touch	Not unusually hot (5-1)				✓	2 to 3 years
	Mechanical seal (Model VKN-e)	Leakage	Visual check	No leakage (5-1)		✓			1 year (8000-hour operation)
	O-rings	-	-	-					Whenever disassembled
	Others (screws etc.)	-	-	No abnormal condition					As needed
	Appearance	Unusual noise, vibration	Listen Visual check	No abnormal condition	✓				-
	Insulation resistance	Between the ground and each lead wire	Megger tester	1 MΩ or more				✓	-

\*1 The timing of replacing consumables (as a guide) does not mean their guaranteed service life. The service life of parts varies depending on the ambient conditions and the conditions for use.

\*2 Urea grease is adopted for lubrication inside the bearings to extend their service life. Use a bearing into which urea grease is filled.

## 6. Troubleshooting

The following table lists causes of failures and their actions. In the event of a failure, however, you should carefully investigate the problem and ask the vendor to carry out any actions that are not easy to take.

Problem	Cause (Reference page)	Action (Reference page)	Done by *
The pump does not start.	Wiring is disconnected or broken. (3-4)	Check the wires and connections. Repair or replace.	Vendor
	The power fuse is blown.	Replace it with an appropriate fuse.	User
	Tripping of the thermal relay	Check the thermal relay.	User
	Poor connection or contact of power wires (3-4)	Check the wires and connections.	Vendor
	The power voltage is too low. (2-2)	Check the power voltage. Contact the power company.	User
	The motor has failed. (e.g. broken wire of the stator winding)	Repair at vendor's shop. Contact the vendor because disassembly and inspection are required.	Vendor
	Foreign matter is caught in the impeller.	Disassemble, clean, and repair. Contact the vendor because disassembly and inspection are required.	Vendor
	The bearing is rusty. (5-1)	Replace the bearing. (5-1) Contact the vendor because disassembly and inspection are required.	Vendor
	The shaft seal is stiff. (5-1)	Check the shaft seal. Contact the vendor because disassembly and inspection are required.	Vendor
Overload and overcurrent of the motor	The rotation speed is too high.	Check with the tachometer.	User
	The voltage is too high or too low.	Check the power voltage.	User
	Fluctuation of the voltage	Contact the power company.	
	The stator winding is broken, shorted, or grounded.	Contact the vendor because disassembly and inspection are required.	Vendor
	The stator and rotor are in contact due to wear of the bearing. (5-1)	Replace the bearing. (5-1) Contact the vendor because disassembly and inspection are required.	Vendor
	The motor is running in open-phase condition.	Check the wiring.	User
	The dynamic viscosity of the pumping liquid is too high. (2-2)	Use a liquid with low dynamic viscosity.	User
	The discharge rate is high.	Throttle the sluice valve to adjust the rate as per the specifications.	User
	A rotating part is in contact with another part.	Contact the vendor because disassembly and inspection are required.	Vendor
The pump starts, but cannot achieve the specified discharge rate and the specified head.	The pumping liquid contains many bubbles.	Prevent the formation and suction of bubbles.	User
	The rotation direction is reverse. (4-2)	Correct the wiring so that the motor rotates in normal direction. (4-2)	User
	The piping loss is high.	Check the diameter, route and length of the pipes.	User
	The piping is clogged with foreign matter.	Check and clean the piping.	User
	The impeller is worn.	Replace the impeller. Contact the vendor because disassembly and inspection are required.	Vendor
	Foreign matter is accumulated in the impeller and in the casing.	Remove the foreign matter, and check the connections. Contact the vendor because disassembly and inspection are required.	Vendor
	The rotation speed is low.	Check with the tachometer.	User
	The sluice valve is closed.	Open the sluice valve.	User

	The piping is clogged with foreign matter.	Check and clean the piping.	User
	[VKP-e] The suction port is exposed above the liquid level. (3-3)	Adjust the liquid level, for example, by refilling the tank with the liquid or by lowering the installation position of the pump.	User
	There is a leak in the discharge pipe.	Check and repair the pipe.	Vendor
	[VKN-e] Priming is insufficient. (4-1)	Sufficiently prime the pump. (4-1)	User
Overheat of bearing	The bearing is worn or damaged. (5-1)	Replace the bearing. (5-1) Contact the vendor because disassembly and inspection are required.	Vendor
	The grease is deteriorated. (5-1)		
	Incorrect installation of the pump and the piping (3-2)	Check and correctly install them.	User
Unusual noise and unusual vibration of the pump	The bearing is worn or damaged. (5-1)	Replace the bearing. (5-1) Contact the vendor because disassembly and inspection are required.	Vendor
	The motor is running in open-phase condition.	Check the wiring.	User
	The impeller is clogged with foreign matter, thus leading to imbalanced load.	Disassemble and check. Contact the vendor because disassembly and inspection are required.	Vendor
	Cavitation has occurred.	Contact the manufacturer and vendor.	User
	Incorrect installation of the pump and the piping (3-2)	Check and correctly install them.	User
	[VKN-e] Unusual noise from the shaft seal (mechanical seal) (3-2)	Disassemble and check. Contact the vendor because disassembly and inspection are required.	Vendor
An abnormal amount of liquid is leaking from the shaft seal.	[VKN-e] Damage to the mechanical seal (5-1)	If the leakage becomes large, replace the seal. Contact the vendor because disassembly and inspection are required.	Vendor
Water hammer occurs.	Hammering has occurred when the valve is rapidly opened and closed.	Provide a pressure damper (e.g. accumulator).	User

\* The persons who take the Action are specified here (Done by) only as a guide because the extent of actions that can be taken is different depending on the user.

If you have anything unclear—even about the problems whose actions to be done by User, ask the vendor or contact Teral.

## 7. After-sales service



For overhaul, replacement of parts, or repairs, ask the vendor, the service provider specified by the manufacturer, or Teral. Improper work may lead to malfunctions or accidents.

- For maintenance and repairs of the pump, ask the vendor from which you purchased the product or ask Teral.
- If you find anything unusual about the active pump, immediately stop the pump and then check the problem. (Refer to Section “0.
- Troubleshooting” [page 6-1].) For disassembly, inspection, or repair, ask the vendor from which you purchased the product or ask Teral. (Refer to the end of this document.)
- Never repair the pump by yourself because it may lead to danger.
- When you contact the vendor, inform them of the information indicated on the pump nameplate (e.g. pump model and serial number) in addition to the status of the problem.
- For the warranty, refer to “Limited warranties (page I)” on the opening page of this document.

If you have anything unclear about the product, contact the vendor from which you purchased the product or contact Teral.

## 8. Disposal

### 8.1 Precautions for disposal

Before detaching the pump from the system for disposal or replacement, be sure to turn off the main power.



Before detaching the pump, be sure to turn off the main power. Otherwise, the pump may suddenly start up in automatic mode or on other occasions, thus leading to great danger.



When hoisting the pump, pay attention to its center of gravity. Otherwise, the pump may topple over or fall, thus leading to an injury.

- (1) For the model VKP-e, drain liquid from the tank (oil tank) so that the bottom of the pump is exposed above the liquid level.
- (2) Shut the sluice valve on the discharge side, disconnect piping on the discharge side, and then discharge liquid from the pump.
- (3) Disconnect the wiring and piping. (For the layout in the terminal box, refer to “Section 3.5. Precautions for wiring work [page 3-5].”)
- (4) Remove the pump mounting bolts and then hoist the pump. (Refer to “Section 3.3. Precautions for installation [page 3-2].”)  
Because the liquid remaining in the pump may flow out while the pump is detached or moved, take measures against it as needed.
- (5) Dispose of the pump as industrial waste. Dispose of other parts according to your national and local laws and regulations, for example, by asking the specialized waste disposal contractor.

#### Note

Dispose of the pump as industrial waste.

#### Note

For the packing materials that are no longer necessary after installation as well as for used lubricating oils and parts that are no longer necessary after maintenance, inspection, repairs, and replacement, dispose of them according to your national and local laws and regulations, for example, by asking the specialized waste disposal contractor.



***TERAL***

**TERAL INC.**

**Head Office**

230, Moriwake, Miyuyki-cho, Fukuyama-city, Hiroshima, 720-0003, Japan

Tel.084-955-1111 Fax.084-955-5777

**Overseas Div.**

TERAL Koraku Bldg., 2-3-27, Koraku, Bunkyo-ku, Tokyo, 112-0004, Japan

Tel.03-3819-6890 Fax.03-3818-6790