

Coolant Pump

Model : LHW-e / LPW-e / LPW-7W / LKW-e
LFE / LFE-e

⚠ WARNING

Do not operate, service or inspect this pump until you have read and understood this manual.

Keep this manual in a safe place where it can be consulted at any time.

To : All mechanical Contractor

Make sure to supply copies of this manual to the customer's operator maintenance and inspection personnel.

Limited warranties

1. In the event of a failure or breakage under proper use of the product during the warranty period, equipment supplied by Teral Inc. shall be repaired or replaced free of charge within the scope of the relevant part, provided that such failure or breakage is attributable to inadequacy of the design or workmanship of the equipment.
The warranty period of this product shall be one year after the date of delivery.
2. The warranty mentioned in the above clause shall be only the mechanical warranty of the defective part, and shall not cover any expenses or other damage arising from the failure or breakage.
3. In the event of the following failures and breakage, the costs of the repairs shall be borne by the user.
 - (1) Failures and breakage attributable to equipment that was not delivered by Teral Inc.
 - (2) Failures and breakage after the expiration of the warranty period
 - (3) Failures and breakage caused by disasters or force majeure, such as fire, acts of God, or earthquakes
 - (4) Failures and breakage resulting from repairs or modifications made without the consent of Teral Inc.
 - (5) Failures and breakage when parts other than those designated by Teral Inc. are used
 - (6) Failures and breakage caused by use or storage outside the specification range
4. Teral Inc. shall not be liable for the damage caused by incorrect or reckless use of the pump. Cost and expenses incurred for sending engineer(s) in such a case shall be borne by the user.
5. If the cause of the failure is unclear, necessary actions shall be determined through mutual consultation.

<Chargeable repair>

Investigation and repair work after the warranty period shall become chargeable. For any failures that have occurred within the warranty period but that fall outside the above-mentioned warranty coverage, Teral Inc. shall carry out repairs and investigation for a fee.

Purpose of this manual

The purpose of this manual is to provide the user with detailed information necessary to properly operate, maintain and inspect the pump. Incorrect operation of this product may lead to an unexpected accident.

Please use the product correctly according to this instruction manual.

This manual contains the following information and is intended for persons experienced in the operation of pumps, or for those who have been trained by such experienced operators. Only qualified personnel such as licensed electrical engineers are allowed to carry out the electrical wiring work.

Contents

	(Page)
Limited warranties	I
Purpose of this manual	II
Contents	II
1. Safety precautions.....	1-1
1.1 Types and meanings of safety signs and graphic symbols.....	1-1
1.2 Safety precautions.....	1-1
1.3 Location of warning labels and caution labels.....	1-4
2. Configuration and overview of the pump.....	2-1
2.1 Part names and functions.....	2-1
2.2 Standard specifications	2-2
3. Installation	3-1
3.1 Before using the pump	3-1
3.2 Precautions for installation	3-1
3.3 Precautions for piping work.....	3-4
3.4 Precautions for wiring work	3-5
4. Operation.....	4-1
4.1 Check items before test operation.....	4-1
4.1.1 Check items related to the electrical system	4-1
4.1.2 Check items related to the pump.....	4-1
4.2 Running the pump (test operation).....	4-2
5. Maintenance and inspection.....	5-1
5.1 Precautions for maintenance and inspection	5-1
5.2 Replacement of the V-ring (for LPW65-e).....	5-2
5.3 Maintenance checklist	5-4
6. Troubleshooting.....	6-1





1. Safety precautions

1.1 Types and meanings of safety signs and graphic symbols











This instruction manual divides precautions into the following four categories according to the level of hazards (or the severity of the accident). In addition, prohibited or mandatory actions as well as cautions are indicated with a graphic symbol.

Be sure to understand the meanings of the following terms and comply with the content (instructions) of the instruction manual.

■ Explanation of warnings















Safety sign	Meaning
 Danger	Indicates an imminently hazardous situation. Failure to observe this will result in death or serious injury.
 Warning	Indicates a potentially hazardous situation. Failure to observe this will result in death or serious injury.
 Caution	Indicates a potentially hazardous situation. Failure to observe this will result in minor or moderate injury or property damage.
 Note	Indicates information that is in particular to be noted or emphasized.

























■ Explanation of the graphic symbols















				
Don'ts	Do not touch	Do not disassemble	Do not touch with wet hand	Do not expose to water
These graphic symbols indicate prohibited actions (that must NOT be done).				
	This graphic symbol indicates mandatory actions (that must be done).			
Do's				
				
Caution	Electric shock hazard	Rotation hazard	Hot surface	
These graphic symbols indicate existing hazards to beware of.				

1.2 Safety precautions

 Danger	
 	Once the main power is turned on, do not touch any live parts. A high voltage applied to live parts may cause a serious electric shock, thus leading to death.
 	Do not use the product in any explosive atmosphere. Otherwise, it may lead to an injury or fire.

























 Warning	
	Properly move the unit according to lifting instructions. Otherwise, the unit may fall, thus leading to an injury or damage.
	Do not carry out any work with/on the pump that is being lifted. Otherwise, the unit may fall, thus leading to an injury or damage.
	Only those who are authorized by the site manager are allowed to operate the pump. Operation by unskilled personnel may lead to an unforeseen accident.
	Installation, maintenance, and inspection must only be carried out by personnel who have been trained to handle the pump. Operation by unskilled personnel may lead to an unforeseen accident.
 	Only qualified personnel, such as licensed electrical engineers, are allowed to carry out electric work. Otherwise, it may lead to an electric shock, fire, failure, or other problems.
 	Use high-quality wiring equipment and devices, and carry out wiring work safely and securely according to the technical standards for electrical facilities, as well as the indoor wiring regulations. Otherwise, it may lead to an electric shock, fire, or other problems.
	Do not connect the ground wire to a gas pipe or water pipe. Such a connection is illegal and leads to an electric shock, explosion, or fire.
 	Securely install the ground wire and ensure to carry out grounding work. Otherwise, it may lead to an electric leak or electric shock.
	Do not run the unit if abnormal condition is observed in any operation, movement, parts, etc. Otherwise, it may lead to an injury, failure, or various accidents.
 	Correctly and securely connect the wires according to the wiring diagram within the terminal box and the instruction manual. Incorrect wiring may cause a fire, electric shock, failure, or other problems.

 Warning	
<p> Be sure to keep the terminal box cover attached during the operation of the pump. Otherwise, it may lead to an electric shock.</p> <p></p>	<p> Be sure to install the coupling cover during the operation of the pump. Otherwise, it may lead to an injury or damage.</p> <p></p>
<p> After detaching the companion flange from the pump, screw a pipe into it. Otherwise, it may lead to damage or leakage.</p>	<p> Do not forcibly bend, pull, or pinch the power cable or any lead wires of the product.  Otherwise, it may lead to an electric shock or fire.</p>
<p> Check the wiring sections and wires for any looseness.  A loose connection may cause a fire or electric shock.</p>	<p> Before starting the maintenance or inspection work, be sure to stop the pump and turn off the main power of the panel board.  Otherwise, it may lead to an electric shock, injury, damage, or leakage.</p>
<p> Before starting the unit or carrying out maintenance/inspection work, ensure that all the relevant workers are informed of the operation and that there are no workers in the dangerous zone. Otherwise, it may lead to an unforeseen accident.</p>	<p> Before rotating the main shaft by hand to check its smooth rotation, be sure to turn off the main power.  Otherwise, it may lead to an injury or damage.</p>
<p> After turning on the power, do not touch any parts of the pump other than those required for operation.  Otherwise, it may lead to an electric shock or injury.</p>	<p> Do not perform long hours of zero-discharge operation continuously.  Otherwise, the temperature and pressure may increase inside the pump, thus damaging the pump or causing steam to blow off.</p>
<p> Do not put your fingers or foreign objects into any openings or rotating part of the motor during operation.  Otherwise, it may lead to an injury or damage.</p>	<p> For overhaul, replacement of parts, or repairs, ask the vendor or the service center specified by Teral.  If unskilled personnel carry out work that requires special knowledge, it may lead to an accident or failure.</p>
<p> In the event of a power failure, be sure to turn off the power switch. Otherwise, the pump may suddenly start up on restoration of the power, thus leading to an injury.</p>	

 Caution	
<p> Do not use the unit outside the range of the product specifications.  Otherwise, it may lead to an electric shock, fire, leakage, failure, or other problems.</p>	<p> Do not use the unit at an incorrect power voltage. An incorrect voltage may damage the motor.</p>
<p> Do not use a single pump unit as the only means of directly operating key facilities or sustaining life. In the event of a failure, the water supply may stop. Ensure to make a backup unit available for operation.</p>	<p> Before unpacking the delivered container, check that the container is placed in the correct orientation (not upside down). Carefully unpack the container, while paying special attention to nails. Otherwise, it may lead to an injury or damage.</p>
<p> Ensure that the floor at the unit's installation place is waterproofed and fitted with drainage. Otherwise, it may lead to serious damage in the event of leakage.</p>	<p> Do not install two or more different cables or control wires in one pipe or duct. Otherwise, it may lead to malfunction of the product or other equipment.</p>
<p> Do not step on the pump or motor. Otherwise, it may lead to an injury, damage, or other problems.</p>	<p> Do not expose the motor to water.  Otherwise, it may lead to an electric shock, electric leak, failure, or other problems.</p>
<p> Operate the controls carefully. Otherwise, it may lead to an injury or damage.</p>	<p> Never run the pump dry. Otherwise, it may lead to damage or a fire.</p>
<p> Before operation, thoroughly clean (flush) the inside of the piping to remove foreign matter. Otherwise, the piping system may be contaminated with foreign matter, thus leading to an accident or a pump failure.</p>	





Caution

 Do not put a cloth or other covering on the motor. Otherwise, it may lead to overheating or ignition.	 Do not touch the motor body while the pump is running or immediately after the pump has stopped. Otherwise, you may get burns from the hot surface. 
 In the event of an alarm or abnormal condition that cannot be resolved, immediately stop the operation, turn off the power, and then contact Teral or its service provider. Otherwise, it may lead to an accident.	 Do not run the pump with tools or other objects placed on the unit. Otherwise, it may lead to an injury or damage.
 Check that the delivered items are exactly what you ordered. The use of a wrong product may cause an injury or failure.	 Do not hold the strainer located on the tip of the pump. Otherwise, the strainer may come off, thus leading to an injury or damage.
 Do not place any obstacles around the product that may hinder ventilation. Otherwise, it may lead to a fire.	 Do not place any combustibles around the product. Otherwise, it may lead to a fire.
 Do not run the pump at a frequency exceeding 60 Hz (50 Hz for models dedicated to 50Hz). Otherwise, it may lead to motor burnout or a fire.	 Do not touch the impeller, tie bolt, strainer, or other parts of the pump with bare hands. Otherwise, it may lead to an injury or damage.
 Ensure to install an overcurrent protective device. The user is required by the technical standards for electrical facilities to install one. Otherwise, it may damage the product, thus leading to a fire or failure. It is also recommended to install protective devices such as a ground fault interrupter.	 Do not use the unit for pumping any fluids beyond the specified viscosity limit. Otherwise, it may lead to motor burnout or a fire.
 Do not run the pump with its strainer removed. Otherwise, it may lead to an injury or damage.	 Do not touch any terminals or wires when measuring the insulation resistance. Otherwise, it may lead to an electric shock.
 Do not touch the Impeller after removing the strainer. Otherwise, it may lead to an injury.	 Once you turn off the power, wait until the pump stops completely. Do not restart the pump until it does. Otherwise, the main shaft may be subjected to an excessive load, which makes the service life of the pump shorter.
 Do not use thinner or benzine for cleaning the product. Otherwise, the product may be discolored or its coating may be peeled off.	 If you use a solvent for cleaning the product, pay attention to handling of the solvent as well as the environment of use. Otherwise, it may lead to poisoning.
 When you lift the product, pay attention to its center of gravity. Otherwise, the product may topple over or fall, thus leading to an injury.	 Dispose of the product as industrial waste.
 Be sure to conduct inspection according to the Maintenance checklist. Otherwise, you cannot prevent potential failures, thus leading to a higher risk of accidents.	 When you lift the product by hand, pay attention to its weight. Do not allow a single person to lift a product heavier than 15 kg. Otherwise, it may put strain on the body, thus leading to an injury.
 Do not put your fingers or foreign objects into the immersion detecting hole.  Failure to observe this may lead to an injury or damage.	

1.3 Location of warning labels and caution labels

The figure shows the locations of warning labels and caution labels. If these labels become dirty and illegible or if they are peeled off, replace them with a new one.

 **Warning**
  **Caution**
 

Observe all the warnings and cautions affixed to the machine as well as those described in this instruction manual.

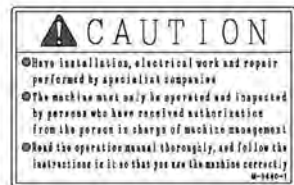
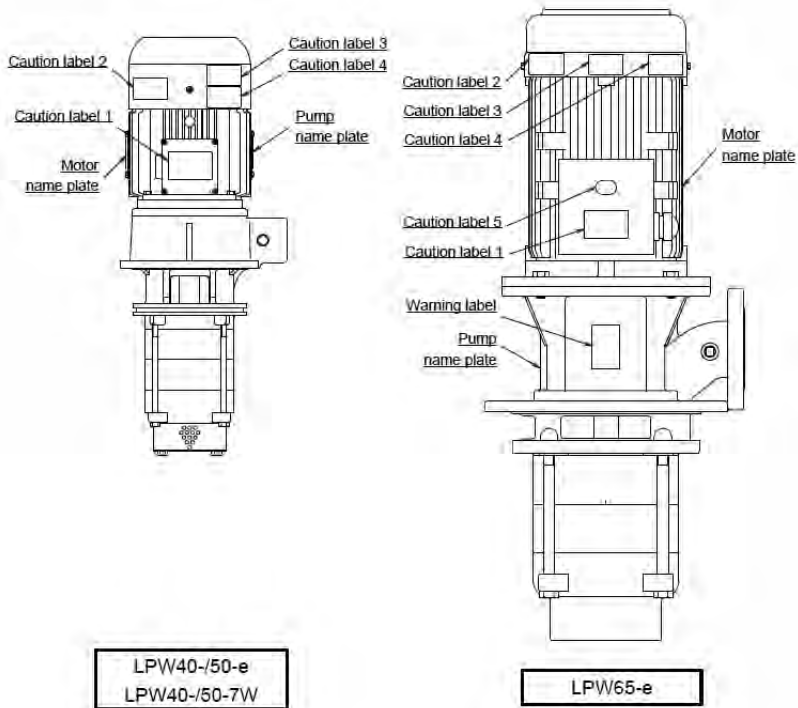
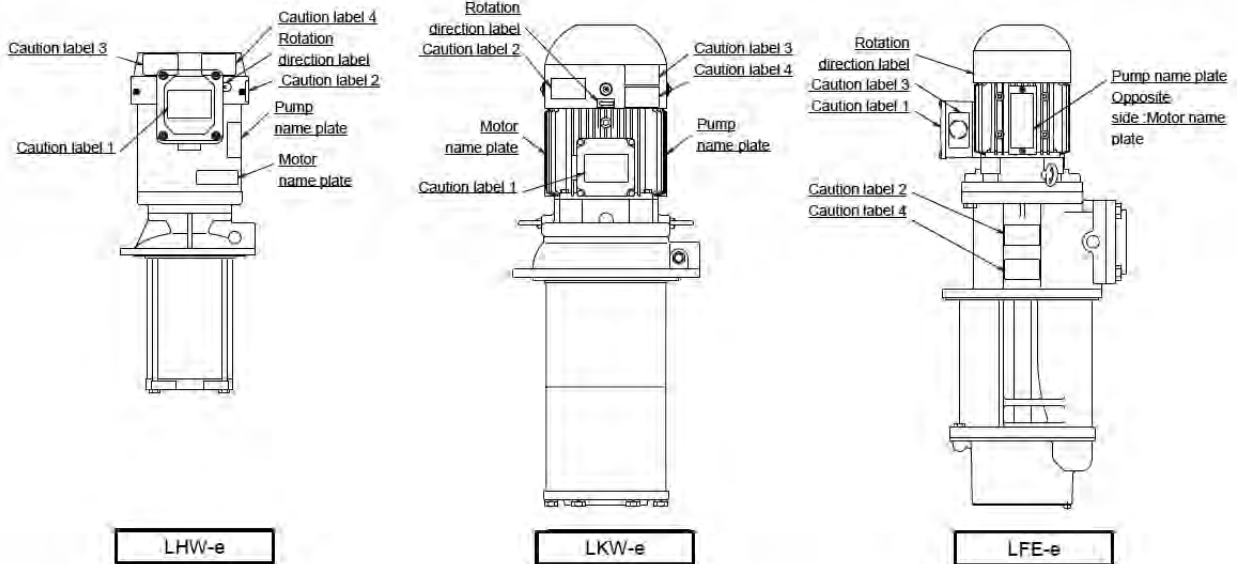

Caution label 1



Caution label 2



Caution label 3

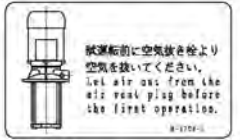

Caution label 4



Caution label 5



Warning label

2. Configuration and overview of the pump

This chapter describes the standard specifications of the pump. If you have purchased a customized product, some information in this chapter may not be applicable to your unit. Refer to the delivery specifications for the details separately.



Do not use this product under any conditions other than those provided in the specifications. Otherwise, it may lead to an electric shock, fire, leakage, or failure.

2.1 Part names and functions

- ① Motor
- ② Discharge port
- ③ Suction port (with strainer)
- ④ Air vent valve

If air cannot be released from the pump to the atmosphere on the discharge piping, you can discharge air using this valve to prevent dry running.

- ⑤ Immersion detecting hole (LHW-e, LKW-e, LPW40/50-e, LPW40/50-7W)

If liquid leakage occurred from the immersion detecting hole, check the shaft sealing part.

- ⑥ Coupling (LPW65-e)
- ⑦ Coupling cover (LPW65-e)

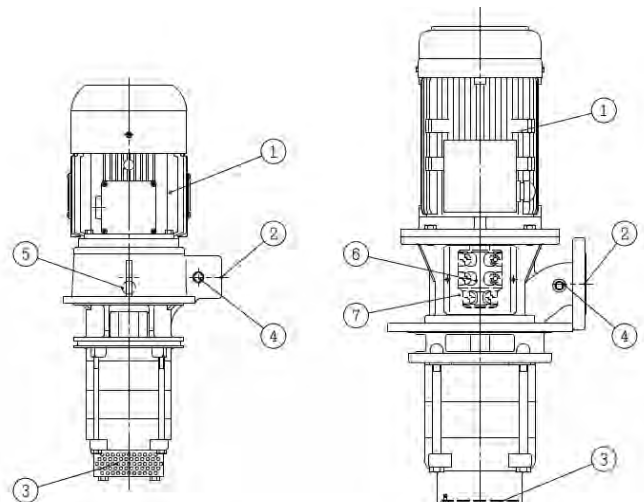

Representing model
(The drawing shows LPW40-e)

LPW65-e

※The appearance is different according to the model.



Be sure to keep the coupling cover and the strainer attached during the operation of the pump. Failure to observe this may lead to an injury.



Do not put your fingers or foreign objects into the immersion detecting hole. Failure to observe this may lead to an injury or damage.

2.2 Standard specifications *

If you have purchased our standard product, refer to the “Standard specifications” table. If you have also purchased a customized product with special specifications, refer to the delivery specifications.

• Standard specifications

Model ^{※1}		LHW-e	LKW-e	LFE/LFE-e	LPW-e	LPW-7W
Nominal diameter(mm)		20	20	32/50/65	40/50/65	40/50
Applicable liquid	Quality	Water-soluble coolant (dynamic viscosity 1mm ² /s)			LPW40 : Water-soluble coolant, liquids of similar viscosity to water containing additives (anti-rust agents) and the like (up to 32 mm ² /s for LPW40C, up to 150 mm ² /s for LPW40D ^{※2})	
	Temperature	0 to 60 °C (No frozen liquid is allowed.)				
Installation location		Indoors; height above sea level: 1,000 m or less; ambient temperature: 0 to 40°C; humidity: less than RH85% (no condensing); place not exposed to direct sunlight; place without any corrosive gas, explosive gas, or vapor in the atmosphere				
Material	Suction casing (Suction cover) Discharge casing	FC200	FC200	FC200	FC200	
	Intermediate casing	ARLS	ARLS +(SUS304)	-	FC200	
	Impeller	ARLS	ARLS	FCD450	FCD450	
	Main shaft	Motor	Equivalent to SUS420J2	S35C	S35C	LPW40/50 : S45C
Pump		-			LPW65 : S45C	
Shaft sealing structure		Sealless structure (without mechanical seal)				
Motor	Type	Totally-enclosed fan-cooled indoor type				
	IP protection	IP44			LPW40/50 : IP44 LPW65 : IP55	IP54
	Power ^{※3}	3-phase 50/60Hz 200/200-220V		3-phase 60Hz 200-220V	3-phase 50/60Hz 200/200-220V	3-phase 60Hz 208-230/460V
	Insulation class	Class F				
	Number of poles	2P				
Coating color		Munsell N1.5				

* 1 All the models that the suffix “-e” is appended to the model name are the products with a built-in premium efficiency (IE3-equivalent) motor. All the models that the suffix “-7W” is appended to the model name are the products with a built-in UL standard motor.

* 2 Note that the product can be used for the water containing additives (anti-rust agents) such as water-soluble or non water-soluble coolant, but cannot be used for water.

* 3 Limit the fluctuations of the power voltage within ±10% of the rated voltage, and also limit the fluctuations of the frequency between -5% and +3% of the rated value. Avoid continuous operation if the voltage is not within ±5% of the rated value or if the frequency is not within ±2% of the rated value.

3. Installation

3.1 Before using the pump

Upon receiving the pump, check the following points first.

The container may greatly incline depending on its center of gravity.



Before unpacking the delivered container, ensure that the container is placed in the correct orientation (not upside down). Pay special attention to nails especially when opening a wooden crate. Otherwise, you may get injured.

- (1) Check the nameplate to verify that the delivered product is exactly what you ordered.
- (2) No part of the product is damaged during transportation.
- (3) All fastening parts including bolts and nuts are securely tightened.
- (4) All the accessories that you ordered have been delivered. (Note that the direct operation type contains the pump and the accessories such as bed in separate packages.)



Do not hold the strainer on tip of the pump during handling. Failure to observe this may cause the strainer to come off, resulting in an injury or damage.



When lifting the product by hand, pay attention to its center of gravity and weight. Do not allow a single person to lift a product heavier than 15 kg. Failure to observe this may cause the burden on the body, resulting in an injury.



Do not run the pump at a frequency exceeding 60 Hz (50 Hz for models dedicated to 50Hz). Failure to observe this may cause an overload and burnout of the motor.

3.2 Precautions for installation

- (1) Install the product in a well-ventilated place with minimum exposure to dust and moisture. In particular, avoid installing the product in a place where the pumping liquid may be splashed on the motor section.



Do not install the product in a place exposed to high temperature and moisture. Failure to observe this may cause heating, ignition or electric leakage.

- (2) Install the product so that the motor can take air in.
- (3) Securely install the product on a flat place without any wobbles.

- (4) Select a convenient place to conduct maintenance and inspection. Secure space for maintenance.
- (5) It is necessary to make a mounting hole larger than the outside diameter of the pump section so that the pump section can fit into the tank (oil tank). See the dimensional outline drawing.
- (6) Install the pump so that the main shaft becomes vertical.
- (7) Use the product with the pump section immersed under the oil level. The suction port should be at least t mm away from the bottom surface of the tank (oil tank) to prevent the strainer from getting clogged with cutting powder, dirt, or other materials. If cutting powder, dirt, or other materials are predicted to accumulate on the bottom of the tank, ensure as large a distance as possible from the bottom at the design stage.

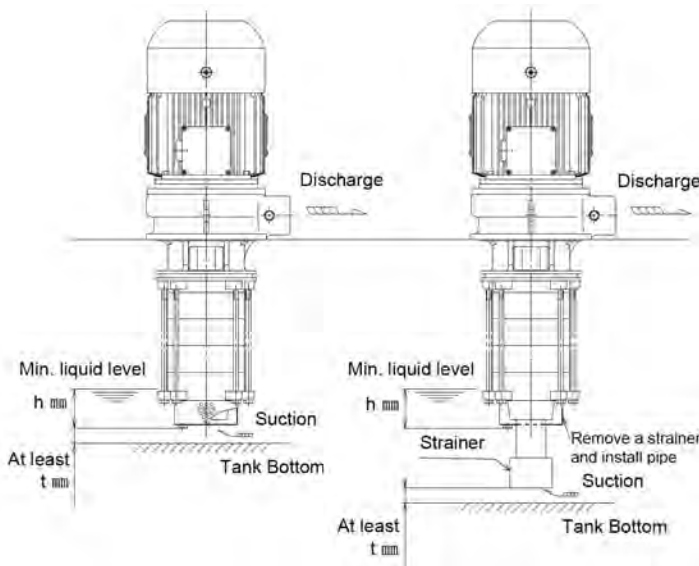

Model	h	t
LHW-e	45	5
LPW40-e(-7W)	65	25
LPW50Z-e	51	25
LPW50ZL-e(-7W)	36	20
LPW65-e	100	50
LKW-e	45	5
LFE32/LFE32-e	60	20
LFE50/LFE50-e	75	20
LFE65-e	100	20

All models

In case that pipes and a strainer are installed (except for LHW-e)

Note

Always keep the liquid level in the tank (oil tank) above the Minimum liquid level. Keep the suction port of the pump at least t mm away from the bottom of the tank (oil tank), and at least 5 mm away for LKW-D-e (series operation).

- (8) For model LKW-D-e, refer to the drawing below and assemble the pump main body and accessories such as bed.

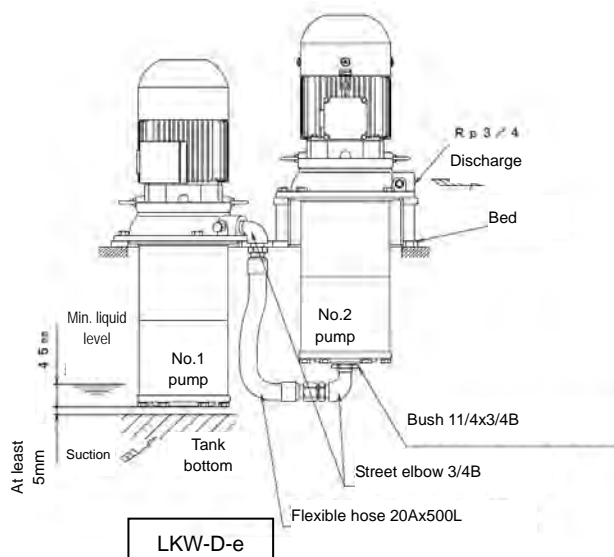



- (9) Install the product at a place where a secondary hazard does not occur in the event of any liquid leak.
- (10) If the system could be exposed to the freezing temperature in winter, be sure to apply antifreeze measures such as heat insulation and heater installation to the pump, valves, piping, etc.
- (11) Securely install the pump.

Note

Securely fix the pump in place with the bolts. Otherwise, it may lead to abnormal vibration or other problems.

- (12) To lift the pump, pass a rope or the like through the hanging hole of a casing for the model LHW-e, LPW40/50-e, LPW40/50-7W and pass a rope or the like through the eyebolt of motor for LPW65-e, LKW-e, LFE/LFE-e. Do not lift the equipment with the pump attached. Failure to observe this may cause the equipment to break and fall down.
- (13) Use extreme care so as not to give an impact or offset load to the pump section during pump lifting or conveyance. The pump may greatly tilt depending on its center of gravity.

 **Warning** 

Before lifting the pump, refer to the catalog, dimensional outline drawing, and other documents to check the weight of the units. Do not lift any units if its weight exceeds the rated load of the hoisting equipment/devices.

 **Caution** 

When lifting the pump by hand, pay attention to its center of gravity and weight. Do not allow a single person to lift a product heavier than 15kg. Otherwise, the pump may topple over or fall, thus leading to an injury.

- (14) If the pumping liquid is cold, condensation may occur inside the motor while the pump is stopped. Take measures to prevent condensation, for example, by installing the pump in a sufficiently dry room or by heating and insulating the motor even when the pump is stopped.
- (15) Carry out touchup painting at a time interval suitable for the environment of use. Depending on the humidity, condensation, and other conditions, rust may form on areas such as threaded parts, worked areas, anticorrosive-coated sections.
- (16) Do not put a cover or filter over the motor. Otherwise, the temperature may increase inside the motor, thus leading to product damage, fire, or other problems.

3.3 Precautions for piping work

- (1) The pipes must be as short and straight as possible with minimal joints and valves. Use pipes whose bore size is equal to or larger than the discharge port of the pump. If the piping size is small or there are many bends, the discharge rate may become low.
- (2) Ensure to provide adequate pipe supports so that the weight of the piping system will not be applied directly to the pump body.



Do not allow the weight of the pipes to rest on the pump.
Failure to observe this may cause the main shaft from coming off center, resulting in equipment damage, vibration, and noise.

- (3) Do not forcibly screw a pipe into the pump. Otherwise, it may break the joint.
- (4) Securely connect the pipes so that the connections are kept completely airtight without leakage. Prevent leaks of liquid and air with seal tape, liquid packing, or other means. Firmly wind the seal tape while paying attention not to block the piping.
- (5) Use a tank (oil tank) with as large a capacity as possible.
* It is recommended to use a capacity of at least three times the discharge volume per minute. Too small a capacity may cause problems such as the rise of liquid temperature, premature strainer clogging with cutting powder, and lower discharge rate caused by bubbles. When pouring a pumping liquid into a tank (oil tank), gently pour it so as not to trap air in.
- (6) Do not allow a large amount of cutting powder, dirt, or other contaminants from entering the pump section. Failure to observe this may clog the pump strainer, damage the pump, or significantly deteriorate the performance. Before using the coolant pumps, implement the treatment of liquid through a net cage, a chip conveyor, a magnetic separator, etc as per the table below.

Pumps that can be used after primary treatment	LPW-e, LPW-7W
Pumps that can be used after secondary treatment	All models

- (7) If water hammer may occur, attach a pressure damper (e.g. accumulator).
- (8) The pump is packaged with a companion flange for the discharge port. Use it as needed. When using the flange, be sure to install the supplied O-ring.
- (9) If there is an upward curve on the discharge pipe, ensure that air can be vented from the section.
- (10) If you provide a relief pipe on the discharge side of the pump, also provide a sluice valve in the middle of the relief pipe to adjust the relief volume.

Note

If the amount of liquid released from the relief pipe is too much, the liquid temperature easily rises in the tank (oil tank).

- (11) On completion of the piping work, be sure to clean the tank (oil tank) to prevent the suction of foreign matter.

3.4 Precautions for wiring work

Danger ! ⚡

Use high-quality wiring equipment and devices, and carry out wiring work safely and securely according to the technical standards for electrical facilities, as well as the indoor wiring regulations. Only qualified personnel such as licensed electrical engineers are allowed to carry out electrical wiring work. Unqualified persons are prohibited by law to carry out wiring work, and it is very dangerous.

Danger ! ⚡

Securely connect the terminals of the power cable. Loose terminals may cause the motor to run in open-phase condition, thus leading to motor burnout.

- (1) Be sure to install a ground fault interrupter and an overload protection device on the primary power side of the pump.

* The starting current of Top Runner efficiency (equivalent to IE3) motor and UL standard motor-equipped products tends to become higher than that of standard efficiency (IE1) motor-equipped products. Therefore, when switching from an IE1 motor-equipped product, it is necessary to verify the applicability of its ground fault interrupter and overload protection device. If you have any questions, contact your nearest office of Teral.

Note

When switching from an IE1 motor-equipped product, it is necessary to verify the applicability of its protection device on the primary side of the pump. Failure to observe this may cause the protective device to trip on startup.

- (2) When connecting to terminals, securely connect to the power according to the below figure.

LHW-e, LPW40/50-e, LPW65-e, LKW-e, LFE (-e)

■ TERMINAL BOX LAYOUT DRAWING

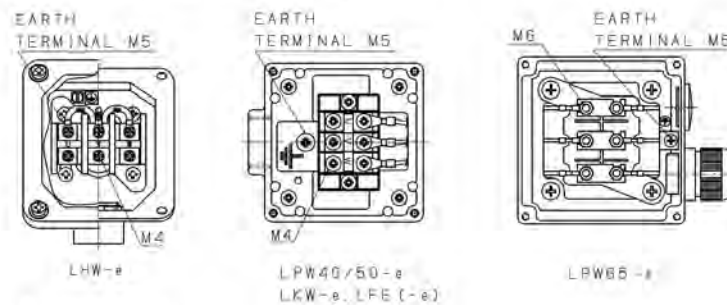

■ CONNECTION

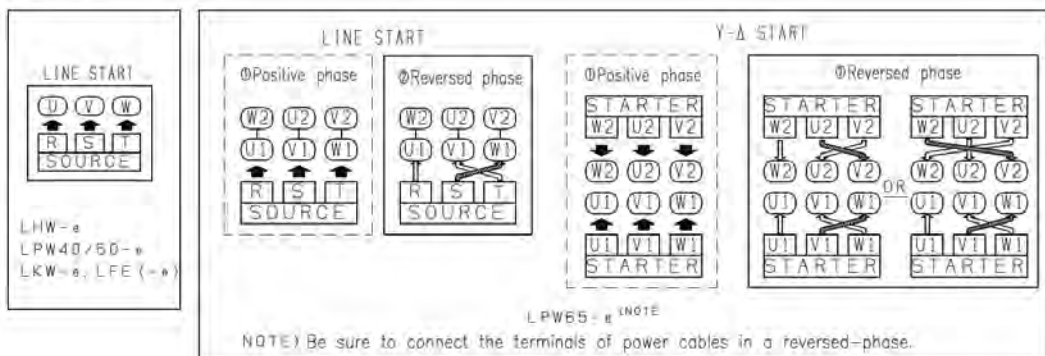

■ TERMINAL BOX LAYOUT DRAWING

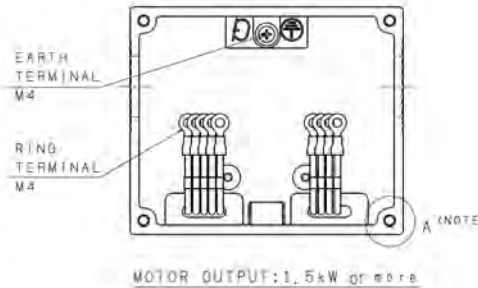
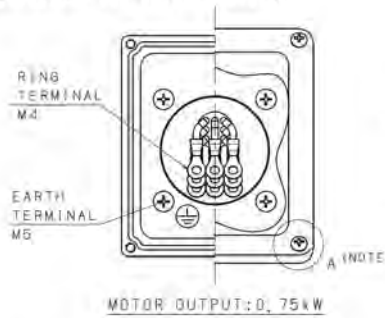

■ CONNECTION

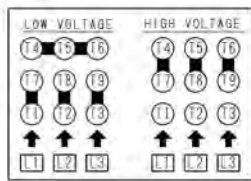

NOTE) When you install the terminal box cover, install it so that an attachment hole (large) of packing may come to the A part.

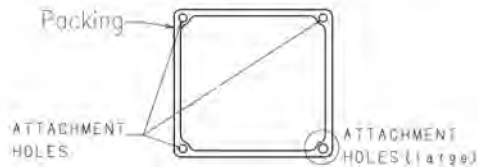

- (3) Be sure to attach a ground wire to prevent an electric shock.
Connect the ground wire to the ground terminal inside the terminal box of the motor.

Warning

Connecting a ground wire to gas or water pipes is illegal and extremely dangerous.

- (4) To prevent the terminal block and power cable of the motor from being pulled, fasten the power cable to the terminal box with the cable lock.

Warning

Do not change the orientation of the terminal box.
Failure to observe this may cause the liquid to entering the terminal box, thus leading to an electric shock.

- (5) To prevent overload and burnout of the motor, it is recommended to use a thermal relay for motor protection.
- (6) Carry out adequate dust-proofing and drip-proofing using a connector or gland so that cutting powder and liquid coolant do not enter the terminal box through the external wiring hole.
- (7) Pass the power cable through a metal tube or a metal conduit for shielding, and connect a ground wire to the outer surface of the tube.

- (8) Limit the fluctuations of the supply voltage within $\pm 10\%$ of the rated voltage, and also limit the fluctuations of the frequency between -5% and $+3\%$ of the rated value. Although you can run the pump in these ranges, avoid continuous operation if the voltage is not within $\pm 5\%$ of the rated value or if the frequency is not within $\pm 2\%$ of the rated value. Otherwise, it may overload the pump, thus leading to motor damage or a fire.

Even if the power fluctuations fall within the allowable ranges, the pump characteristics, motor characteristics, and the temperature rise of the motor may differ from those at the rated voltage and frequency.

- (9) For direct operation type, set the circuit so that the pumps starts from No.1 then No.2 (or together) and stops from No.2 then No.1 (or together).

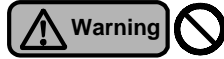

Never start the operation with No. 2 pump nor operate No.2 pump only; it will cause idle operation, leading to the product damage.

(10) Precautions for using the inverter drive

- Ensure that the electric current during operation does not exceed 90% of the rated value.
- Ensure that the minimum frequency is set to 20Hz.
(Contact us if you need to run the drive at 20Hz or lower.)
- When driving a 400V-class motor, contact Teral. In some cases it might be necessary to take measures for inverter surge.
- An inverter-driven motor generates a magnetic sound which may be annoying compared with the drives using commercial power supply. Although this magnetic sound does not cause an adverse effect on the quality of the motor, some inverters allow the user to adjust the tone by changing the carrier frequency. However, changing the frequency may reduce the allowable output of the inverter. Pay particular attention when selecting the inverter.
- If the pump and motor produce resonance during normal operation, do not run them in the range of the rotation speed.



Do not run the pump at a frequency exceeding 60 Hz (50 Hz for models dedicated to 50Hz). Failure to observe this may overload the motor, causing it to burnout. If the models dedicated to 60Hz are run at 50Hz, the performance will deteriorate.

- (11) For LPW65-e, be sure to connect the terminals of power cables in a reversed-phase (by exchanging R with T of the power cables). If the terminals are connected in a positive phase, the pump rotates in the reverse direction, which may cause damage. For the other models, connect the terminals of power cables in a positive phase.



For LPW65-e, be sure to connect the terminals of power cables in a reversed-phase (by exchanging R with T of the power cables). If the terminals are connected in a positive phase, the pump rotates in the reverse direction, which may cause damage.



4. Operation

4.1 Check items before test operation

4.1.1 Check items related to the electrical system

- (1) Check that the equipment is correctly wired.
- (2) Check that the terminals are securely connected.
- (3) Check that the equipment is securely grounded.
- (4) Check that the setup value of the overload protection device is consistent with the rated current value of the motor.

(The rated current of pump should be included in the setting range of the device around the middle.)

 **Warning**  



Do not use the product at any voltage other than the rated value.
Excessive voltage may cause a fire or electric shock.

4.1.2 Check items related to the pump

 **Caution** 

Do not allow a large amount of foreign matter from entering the pump.
Failure to observe this may cause damage to the sliding parts (e.g. bearings) inside the pump, leakage or unusual noise.





- (1) Ensure that the liquid level in the tank (oil tank) is above the "Minimum liquid level."

 **Caution** 

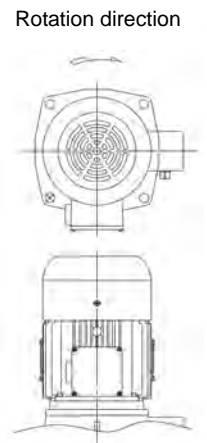
Never run the pump dry (running the pump when the liquid level is below the Minimum liquid level). Failure to observe this cause the sliding parts inside the pump to seize up.

- (2) Check the rotation direction. Normal rotation is clockwise when viewed from the motor side. (See the right figure.)
- (3) To rotate the shaft by hand, insert a flat-blade screwdriver through the fan cover of the motor and turn its shaft (Remove the end cap from the motor shaft). If the rotation is stiff or not uniform, there may be some rust or foreign matter inside the pump. Inspect the pump in such a case.
- (4) After rotating the shaft by hand, install the end cap again.





 **Warning**   

Before rotating the main shaft by hand to check it, be sure to turn off the main power. An unexpected start of the pump may cause an accident.

- (5) Open the air vent valve to release air. After the air release, close the air vent valve. If no air vent valve is provided, open the valve on the discharge piping to release air.

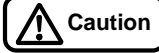

(6) If you run the motor at variable speed with the inverter, be sure to check the following points through test operations.

- The pump may produce resonance depending on installation conditions. If the pump produces resonance, avoid that frequency.
- If the operation frequency is low or the dynamic viscosity of the pumping liquid is high, the pump may not discharge any liquid.
- Do not run the pump at a frequency exceeding 60 Hz (50 Hz for models dedicated to 50Hz). Failure to observe this may cause burnout of the motor.



 **Caution** 

Do not run the pump at a frequency exceeding 60 Hz (50 Hz for models dedicated to 50Hz). Failure to observe this may cause an overload and burnout of the motor. If the models dedicated to 60Hz are run at 50Hz, the performance will deteriorate.

4.2 Running the pump (test operation)

 **Warning**  





Be sure to attach the cover of the terminal box of the motor. Failure to observe this may cause an electric shock.

 **Warning**  





Be sure to keep the coupling cover and the strainer attached during the operation of the pump. Failure to observe this may cause an injury.

 **Warning** 

Do not operate the pump if any abnormal condition is observed or if there is anything wrong with the parts, components, etc. during the check before test operation. Failure to observe this may cause an injury, failure, accident, or other problems.

 **Warning**   



If the liquid used exceeds 40°C, do not touch the pump. Failure to observe this may cause burn on the skin due to high temperature of the pump.

 **Warning**   

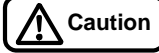

Do not touch the motor during operation or immediately after the stop of operation. Failure to observe this may cause burn on the skin due to high temperature of the pump.

- (1) Check the rotation direction of the pump by turning ON and OFF the power switch once or twice. For LKW-D-e (series operation), turn ON in the order of No.1 pump and No.2 pump or both pumps simultaneously, and turn OFF in the order of No.2 and No.1 or both simultaneously. Normal rotation is clockwise when viewed from the motor side. (For LPW65-e, be sure to connect the terminals of power cables in a reversed-phase (by exchanging R with T of the power cables). If the terminals are connected in a positive phase, the pump rotates in the reverse direction, which may cause damage.)



If the pump rotates in reverse, swap two of the three wires of the power cables.

 **Caution** 

Do not check the rotation direction by running the pump dry. Running the pump dry even for a short time may cause damage to the sliding parts (e.g. bearings) in the pump, leakage or unusual noise.



 **Caution** 

Avoid reverse rotation because it may cause a failure.
For the model LPW65-e, be sure to connect the terminals of power cables in a reversed-phase to prevent the reverse rotation.

 **Caution**  

Do not run the pump dry, and do not allow a large amount of air or foreign matter from entering the pump. Failure to observe this may cause damage to the sliding parts (e.g. bearings) in the pump, disability of pumping, leakage or unusual noise. It may also heat the pump, thus leading to burns.

- (2) If an air vent valve is installed on the pump, slightly open the valve upon startup, and confirm that liquid is discharged. After confirming the discharge, ensure to close the air vent valve.
- (3) Turn on the power to start the pump. For LKW-D-e (series operation), run the pump in the order of No.1 pump and No.2 pump or both pumps simultaneously

 **Warning** 

Never start the operation with No. 2 pump nor operate with No.2 pump only; it may cause the pump dry running, leading to the product damage.

- (4) During the initial period of pump operation and circulation, gradually open the sluice valve on the discharge side to circulate liquid at a flow rate (flow velocity) higher than the normal operation.
- (5) Adjust the sluice valve on the discharge side so that the specified pressure is achieved. Do not continue no-discharge operation for a long time. Long hours of continuous no-discharge operation will increase the liquid temperature in the pump. Therefore, allow a small amount of liquid to flow as per table below, or if you no longer use the liquid, stop the pump. Too hot liquid may reduce the service life of the motor or damage the shaft seal.

Model	Minimum flow of liquid (L/min)
LHW-e, LFE/LFE-e	2
LKW-e, LPW-e,LPW-7W	6



Do not perform long hours of no-discharge operation continuously. Failure to observe this may increase the temperature in the pump, resulting in an unexpected failure.

- (6) When the liquid level is too low, the pump may take air in and decrease the discharge rate, thus making it impossible to pump the liquid. Keep the liquid level above the “Minimum liquid level” indicated in the Dimensional outline drawing. Note that, however, this liquid level changes depending on the viscosity and liquid surface condition. For safety, set the liquid level high enough, but at a level below the “Maximum liquid level” indicated in the outline drawing.
- (7) For the frequency of the startups and shutdowns, refer to the table below.

Model	Allowable frequency of the startups and shutdowns (times / hour)
LHW-e, LPW40/50-e, LPW40/50-7W, LKW-e, LFE/LFE-e	60
LPW65-e	20



Minimize the frequency of startups and shutdowns of the pump because their high frequency may quickly damage the pump.

- (8) In the event of a power failure during operation, be sure to turn off the power.
- (9) Before restarting the pump, confirm that the pump has completely stopped.



Before restarting the pump, be sure to check that the pump has completely stopped. Turning on the power while the pump is still rotating causes an excessive torque on the pump and may cause a failure.

- (10) Avoid sudden pressure fluctuations during the operation of the pump.
- (11) Check for any abnormal pressure, electric current, vibration, noise, and other conditions. If you find any abnormal conditions, take appropriate actions after consulting the Section “6. Troubleshooting (page 5-4).”

Refer to the following chart for vibration vs. rotation speed.

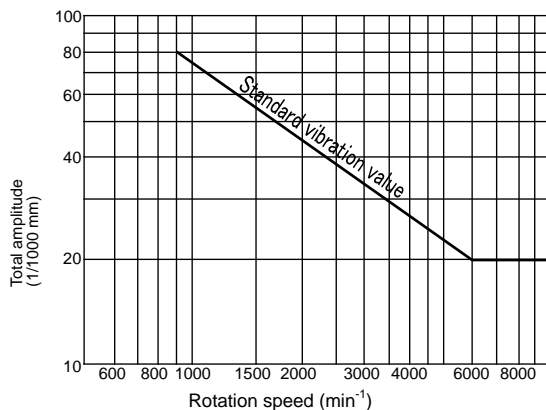

Standard vibration value at the bearing section

[For reference only]

Relation between the total amplitude (a) and the vibration velocity (V)

$$a = \frac{V \times 6 \times 10^4}{\pi \times n}$$

- a: Total amplitude (μm)
- V: Vibration velocity (mm/s)
- n: Equipment rotation speed (min⁻¹)

(12) Do not allow a large amount of cutting powder from entering the pump. Failure to observe this may clog the pump strainer, damage the pump, or significantly deteriorate the performance. If the pump is used in processes such as grinding, milling, or end milling in which a large amount of cutting powder is discharged, select the pump carefully.

(13) Stop the pump.



Keep the cocks of the pressure gauges, compound pressure gages, and other parts closed all the time except when they are used for measurement. Otherwise, they become more susceptible to failure.



Do not run the pump using the power beyond the allowable current value. Otherwise, the motor may burn out.



Do not put your fingers or other objects into the opening of the motor. Otherwise, it may lead to an electrical shock or injury.

5. Maintenance and inspection



Before checking the pump, be sure to turn off the main power. The pump may suddenly start up in automatic mode or on other occasions and lead to a great danger.



Before starting the unit or carrying out maintenance/inspection work, ensure that all the relevant workers are informed of the operation and that there are no workers in the dangerous zone.

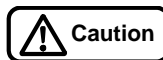

For overhaul, replacement of parts, or repairs, ask the vendor, the service center specified by Teral, or your nearest office of Teral. Incorrect work may cause a failure or accident.

5.1 Precautions for maintenance and inspection

(1) Observe the following points, in particular, during daily inspection.

- ① A large deviation in the pump's discharge pressure, electric current, vibration, noise, or other conditions from the normal status is a sign of a failure. Therefore, immediately take measures, referring to the Maintenance checklist in Section "5.3 Maintenance Checklist".
For this purpose, it is recommended to keep an operation log.
 - ② If the bearing temperature gets abnormally high, immediately stop the pump and check the bearing. The temperature is normal if the temperature difference between the motor surface and the atmosphere does not exceed 40°C.
 - ③ Since shielded grease filled bearings are used, there is hardly any need for maintenance of the bearings such as refilling of grease. Replace the bearings if they generate unusual noise or vibration.
- * Lithium grease or Urea grease is used as lubricating grease in bearings as below. Use bearings into which the same type of grease is filled. When you replace the parts, it is recommended to use a grease equivalent to the following.
- LHW-e: Bearings by NTN (MP-1 grease)
 - LPW40/50-e, LKW-e, LFE/LFE-e: Bearing by NSK (EA2 grease), Bearings by NACHI(FNS3D grease)
 - LPW65-e : Urea grease
 - LPW-7W 0.75kW : Lithium grease • 1.5kW or more : Urea grease
- ④ An oil seal is attached to the bearing section to prevent the entry of liquid. When you replace a bearing, also replace its oil seal with a new one.
 - ⑤ If an oil seal or V-ring is used, high-frequency sound (rubber squeak) may occasionally be generated, but it is not a pump failure. You can continue to use the pump with the same good quality.
 - ⑥ Keep the cocks of the pressure gauges and compound gauge closed all the time except when inspection is required.

- ⑦ In the event of a power failure, be sure to turn off the power. The pump may suddenly start up on restoration of the power, which leads to a danger.



In the event of a power failure, be sure to turn off the power switch.
The pump may suddenly start up on restoration of the power, which leads to a danger.

- (2) Periodically perform cleaning operation as follows:

- ① Clean any dirt, oil, and other deposits off the outer surface of the coolant pump.
- ② Cutting powder deposited in the tank (oil tank) may cause a pump failure. Periodically clean the tank (oil tank).
- ③ Check the strainer of the pump for any clogging. Clean it if it is clogged.



Periodically clean the strainer located on the pump suction side. A clogged strainer may cause pressure fluctuations, a lower discharge rate, unusual noise, and other problems, thus leading to a pump failure.

- (3) If you do not use the pump for a long time, observe the following points:

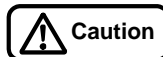

If you do not use the pump for a long time, turn off the power for safety. Otherwise, accumulated dust may cause heat-generation or ignition.

- ① To prevent possible freezing inside the pump in winter, make sure to take antifreeze measures such as heat insulation or the installation of a heater to the pump or completely drain the pump.
- ② If you have a backup pump, run it from time to time to make it available for operation at any time.

5.2 Replacement of the V-ring (for LPW65-e)

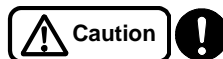

The V-ring is an all rubber seal to prevent, and rotates with friction against the steel plate in a high speed, which provides a sealing function. When the pumped liquid contains a large amount of cutting power or the like, the service life of the V-ring can be shortened. Exchange the V-ring periodically in the following procedure.

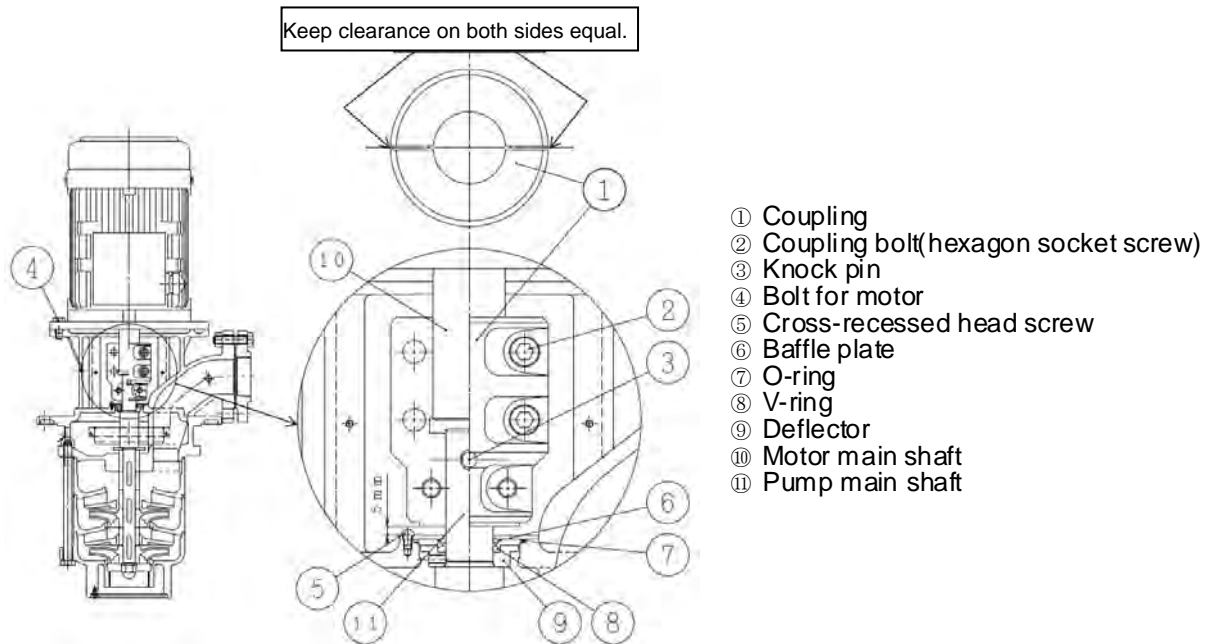

(1) Disassembly procedure

- ① Remove the coupling cover.
- ② Remove the coupling bolts (hexagon socket screw) and dismount the coupling.
When dismantling the coupling, remove the knock pin together.
- ③ Remove the motor mounting bolts connecting the discharge casing and the motor, and dismount the motor.
- ④ Remove the cross-recessed head screws and remove the baffle plate.
- ⑤ Remove the O-rings and V-ring.

(2) Assembly procedure

- ① Exchange both the O-ring and the V-ring with new ones.

Note

Securely push the V-ring into the deflector.

- ② After the replacement is completed,. Reassemble the baffle plate (new one), cross-recessed head screws in the reverse order of disassembly procedure. Apply grease on the sliding part of the baffle plate when installing it (for lubrication of the V-ring).
- ③ Mount the motor onto the discharge casing and fasten it with the bolts.
- ④ Mount the coupling. When mounting the coupling, insert the knock-pin into the main shaft and holding with the coupling. The coupling bolts and nuts should be temporarily fastened at this point.
- ⑤ Lift up the main shaft and insert the fitting plate between the bottom of the coupling and the baffle plate.

Note

Turn the coupling by hand and check if it turns freely without partial contact. If it does not turn smoothly, repeat the disassembly and reassembly procedures.

- ⑥ Tighten the coupling bolts in such a manner that clearance on both sides of the coupling will be nearly equal. Fasten the bolts using a torque wrench with a tightening torque of 40 to 45 Nm. Be careful as insufficient tightening torque may lead to damage of the pump.
- ⑦ Remove the fitting plate.
- ⑧ Turn the coupling by hand and check if it turns freely without partial contact. If it does not, repeat the disassembly and reassembly procedures.
- ⑨ Install the coupling cover.

5.3 Maintenance checklist

Item	Inspection point	Inspection item	Inspection method	Criterion (Reference page)	Inspection interval				Consumables	
					Daily	Monthly	Half-yearly	Yearly	Timing of replacement (as a guide) ^{*1}	
Ambient conditions	Temperature	Check against the specified range.	Measure	Between 0 and 40°C (2-2)	✓				-	
	Humidity		Measure	Less than 85% RH (2-2)	✓				-	
	Dust and other contaminants		Visual check	No dust or other contaminants	✓				-	
Power	Power terminal block	Voltage	Measure	Specified voltage (2-2)			✓		-	
		Voltage fluctuation	Measure	Within the allowable fluctuation range (2-2)			✓		-	
		Loose screws	Retighten	Securely tightened				✓	-	
Pump and motor	Impeller	Clogging	Disassemble and inspect	No clogging				✓	-	
		Wear	Disassemble and inspect	No abnormal condition				✓	When worn out	
	Siphon prevention hole	Clogging	Disassemble and inspect	No clogging				✓	-	
	Main shaft and its surrounding area	Smooth rotation	Rotate by hand	Rotation is smooth and uniform (4-1)				✓	-	
	Motor	Bearing	Heat-generation, abnormal noise, vibration-	Touch, Listen, visual check	No abnormal condition(5-1)				✓	3 years
		Oil seals	Leakage	Visual check-	No leakage(5-1)				✓	3 years (when replacing bearing)
	Baffle plate part (LPW65-e)	Leakage	Visual check-	No leakage		✓			V-ring/baffle plate: 1 year O-ring: Whenever disassembled	
	O-ring	-	-	-					Whenever disassembled	
	Others (screws etc.)	-	-	-						
	Appearance	Unusual noise, vibration	Listen Visual check	No abnormal condition	✓				-	
Insulation resistance	Between the ground and each lead wire	Megger tester	1 MΩ or more				✓	-		

*1 The timing of replacing consumables (as a guide) does not mean their guaranteed service life. The service life of parts varies depending on the ambient conditions and the conditions for use.

*2 lithium grease or Urea grease is used as lubricating grease in bearings as below. Use bearings into which the same type of grease is filled. When you replace the parts, it is recommended to use a grease equivalent to the following.

- LHW-e: Bearings by NTN (MP-1 grease)
- LPW40/50-e, LKW-e, LFE/LFE-e: Bearing by NSK (EA2 grease), Bearings by NACHI(FNS3D grease)
- LPW65-e : Urea grease
- LPW-7W 0.75kW : Lithium grease • 1.5kW or more : Urea grease

6. Troubleshooting

If you find any abnormal conditions of the pump, carefully investigate the problem. For overhaul, replacement of the parts or repairs, ask the vendor or contact Teral or our servicing companies.

Problem	Cause (Reference page)	Action (Reference page)
The pump does not start	Wiring is disconnected or broken.	Check the wires and connections. Repair or replace.
	Poor connection or contact of power wires (3-4)	
	The power fuse is blown.	Replace it with an appropriate fuse.
	Tripping of the thermal relay	Check the thermal relay.
	Contact failure of switching part	Check the contact part to repair.
	The power voltage is too low. (2-2)	Check the power voltage. Contact the power company.
	The motor has failed. (e.g. broken wire of the stator winding)	Contact Teral or our servicing companies because inspection and replacement of the motor are required.
	Foreign matter is caught in the impeller.	Contact Teral or our servicing companies because disassembly and inspection are required.
	The sliding part (liner ring, bearing metal part) is burning.	
The bearing is rusty. (5-1)		
The pump starts, but cannot achieve the specified discharge rate and the specified head	The pumping liquid contains many bubbles.	Prevent the formation and suction of bubbles.
	The rotation direction is reverse. (4-2)	Correct the wiring so that the motor rotates in normal direction. (4-2)
	The piping loss is high.	Check the diameter, route and length of the pipes.
	The piping is clogged with foreign matter.	Check and clean the piping.
	The impeller is worn.	Contact Teral or our servicing companies because disassembly and inspection are required.
	Foreign matter is accumulated in the impeller and in the casing.	
	The rotation speed is low.	Check with the tachometer.
	The sluice valve is closed.	Open the sluice valve.
	There is a leak in the discharge pipe.	Check and repair the pipe.
	The strainer on the suction port is clogged.	Check and clean the strainer.
	The suction port is exposed above the liquid level.	Adjust the liquid level, for example, by refilling the tank with the liquid or by lowering the installation position of the pump.
Overload and overcurrent of the motor	The rotation speed is too high.	Check with the tachometer.
	The voltage is too high or too low. (2-2)	Check the power voltage.
	Fluctuation of the voltage	Contact the power company.
	A 50Hz pump is run in the 60Hz power zone.	Check the nameplate.
	The stator winding is broken, shorted, or grounded.	Contact Teral or our servicing companies because disassembly and inspection are required.
	The stator and rotor are in contact due to wear of the bearing. (5-1)	
	A rotating part is in contact with another part.	
	The motor is running in open-phase condition.	Check the wiring.
	The specific gravity or the dynamic viscosity of the pumping liquid is too high. (2-2)	Use a liquid with low specific gravity and low dynamic viscosity.
	The discharge rate is high.	Throttle the sluice valve to adjust the rate as per the specifications.

Problem	Cause (Reference page)	Action (Reference page)
Overheat of bearing	The bearing is worn or damaged. (5-1)	Contact Teral or our servicing companies because disassembly and inspection are required.
	The grease is deteriorated. (5-1)	Replace the bearing. (5-1)
	Incorrect installation of the pump and the piping (3-1)	Check and correctly install them.
Unusual noise and unusual vibration of the pump	The bearing is worn or damaged. (5-1)	Contact Teral or our servicing companies because disassembly and inspection are required.
	The motor is running in open-phase condition.	Check the wiring.
	The impeller is clogged with foreign matter, thus leading to imbalanced load.	Contact Teral or our servicing companies because disassembly and inspection are required.
	Cavitation has occurred.	Consult Teral or our servicing companies.
	Incorrect installation of the pump and the piping (3-1)	Check and correctly install them.
Water hammer occurs	Hammering has occurred when the valve is rapidly opened and closed.	Provide a pressure damper (e.g. accumulator).

TERAL

TERAL INC.

Head Office

230, Moriwake, Miyuyki-cho, Fukuyama-city, Hiroshima, 720-0003, Japan

Tel.084-955-1111 Fax.084-955-5777

Overseas Div.

TERAL Koraku Bldg., 2-3-27, Koraku, Bunkyo-ku, Tokyo, 112-0004, Japan

Tel.03-3819-6890 Fax.03-3818-6790